

LINDY

CPU Switch Quad View

4 in 1
Konsolumschalter

Installation and Operation Manual



LINDY - Elektronik GmbH
Tel.: 0049 (0) 6251 470050

Markircher Str. 20
Fax: 0049 (0) 6251 4700530

D - 68229 Mannheim
mail: info@lindy.de

LINDY

CPU Switch Quad View

4 in 1 - KVM Switch

©opyright LINDY Elektronik GmbH

Version 1.20c
15.05.2005

Table of Contents

INTRODUCTION	1
Features	1
Hardware	2
- Frontpanel	2
- LED Indicators	2
- Pushbuttons	3
- Additional button functions	4
- Rear panel	5
- Connectors	5
Remote Operation	6
INSTALLATION	7
Connect power to unit	7
Connecting console (monitor, keyboard and mouse)	7
Connecting computers	8
Powering up the system	8
KEYBOARD COMMANDS	9
Multiple Hotkey / Double Click Hotkey	9
Multiple Hotkey Commands	10
- Quad - Fullscreen - Picture in picture (PiP Function)	10
- Select Computer	10
- Keyboard / mouse access switching in Quad Mode	10
- On Screen Display (OSD) Entry	11
- Basic Setting - Output resolution - Enter PiP Menu	11
Double Click Hotkey Commands	11
- Quad - Fullscreen - Picture in picture (PiP Function)	11
- Select Computer	12
- Keyboard and mouse switching in Quad Mode	12
- On Screen Display (OSD) Entry	12
- Basic Setting - Output resolution - Enter PiP Menu	12
ON SCREEN DISPLAY	13
OSD - Main Menu	13
OSD - Navigation	13
OSD - Overview - Menu Structure	14
OSD SYSTEM - Hotkey	15
OSD SYSTEM - Hotmouse - Hotmouse Function	16
OSD SYSTEM - Hotmouse - Hotmouse Cursor Activation	16
OSD SYSTEM - Hotmouse - Hotmouse Cursor in Fullscreen Mode / Quad Mode	17
OSD SYSTEM - Hotmouse - Hotmouse Cursor in PiP Mode	18
OSD SYSTEM - Hotmouse - Hotmouse Menu Activation	20
OSD SYSTEM - Hotmouse - Hotmouse Menu	21
OSD SYSTEM - Quad Mode	22
OSD SYSTEM - OSD Position	23
OSD SYSTEM - OSD Language	23
OSD SYSTEM - Security - Security level	24
OSD SYSTEM - Test Pattern	27
OSD SYSTEM - Disable Channel	28
OSD MODE - PiP	29
OSD MODE - Start	32



TABLE OF CONTENTS

Table of Contents

ON SCREEN DISPLAY (continued)

OSD CONFIGURATION - Backup	33
OSD CONFIGURATION - Recall	33
OSD CONFIGURATION - Defaults	34
OSD CONSOLE - Video Output	35
OSD CONSOLE - Keyboard Layout	36
OSD CONSOLE - Multi Monitor	36
OSD CONSOLE - EDID	37
OSD VIDEO - Video Input	38
OSD VIDEO - Brightness	39
OSD VIDEO - Contrast	39
OSD VIDEO - Horizontal Position	39
OSD VIDEO - Vertical Position	39
OSD VIDEO - Screen Width	40
OSD VIDEO - Phase	40
OSD VIDEO - Format - Fit to screen	41
OSD VIDEO - Format - PiP Design on wide screen monitor	42
OSD COMPUTER - Keyboard	43
OSD COMPUTER - Mouse	43
OSD COMPUTER - Reset PS/2	44
OSD HELP - Command	45
OSD HELP - About	45
OSD HELP - Contact	45
SERVICE	46
Maintenance and Repair – Technical Support	46
SERIAL PORT	47
Firmware Update	47
Serial Cable	48

Thank you for choosing Quad View Switch from LINDY. This product represents the latest state-of-the-art technology in keyboard-monitor-mouse switching and additionally allows simultaneous monitoring of four different computer video sources on a single screen.

Please read this manual before installing and operating the unit.

FEATURES

DISPLAY MODES:

The following display modes are available:

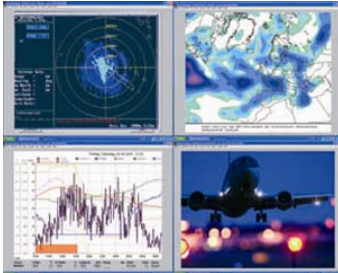

QUAD MODE

In this mode, the screen is split into four fields of equal size each displaying the entire screen contents of four different video sources.



FULLSCREEN MODE

In Fullscreen Mode, one of the four computers' video sources is displayed in full screen size and maximum resolution.



Picture in picture Function (PiP)

Using this feature, the full screen display of one of the four video sources is accompanied by one to three small images (thumbnails) of the other video sources on the right hand margin of the screen allowing simultaneous monitoring. The different PiP designs are described in chapter OSD (pages 29 and 30).

OPERATION:

Use either buttons on front of the unit, keyboard commands (hotkeys) or mouse functions (hotmouse) for switching channels or selecting the display mode (Quad / Fullscreen / PiP).

All device parameters may be set and stored with an On Screen Display (OSD). Use buttons on front of the unit or keyboard command to access the OSD.

LED indicators on the front panel show the actual status of the unit.

RS232 serial port on the rear panel is used to load firmware updates to the unit.

VGA / DVI:

Quad View Switch supports analog VGA as well as digital DVI. All combinations of DVI and VGA (graphic cards and monitors) are supported, allowing equipment to be mixed. Resolutions up to 1920 x 1200 px @ 60Hz (digital) are supported.

KEYBOARD/MOUSE:

On console side there are two USB ports available for USB keyboard and mouse connection. For PS/2 devices like KVM extenders etc, use the attached USB-PS/2 adapter.

On computer side use either PS/2 plus Y cable or USB cables (see page 6) for keyboard and mouse connection.

INTRODUCTION

HARDWARE

Front Panel

The Quad View Switch front panel has six status indicators (LEDs) and six buttons. Buttons 1 to 4 switch channels. Indicators 1 to 4 show the status of the channels. Quad and PiP buttons are used to switch to the corresponding „display mode“ and for other functions like opening OSD menu etc.

Status Indicators



Buttons

Front of Quad View Switch

LED Indicators

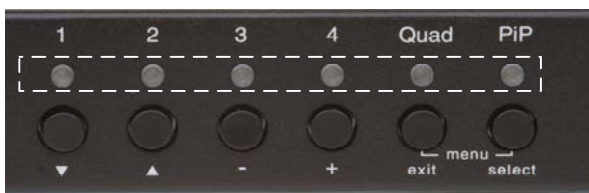

- LEDs 1 to 4
When these LED light up **green**, the corresponding channel has been selected and prepared for keyboard and mouse access. When LED blinks **green**, there is no signal present at the video input of the selected channel.

When the LED lights up **yellow**, there is a signal at video input, but another channel has been selected.

When the LED is **dark**, there is no signal present at video input and another channel has been selected.
- LED QUAD
LED QUAD lights up **green**, when unit operates in Quad Mode. When the LED is **dark**, Quad View Switch is operating in Fullscreen Mode.
- LED PiP
LED PiP lights up **green**, when unit is in Fullscreen or Quad Mode and the PiP function is enabled. It is **dark**, when unit is in the Fullscreen or Quad Mode, but PiP has been switched off.

Note:

LEDs 1 to 4 show the status of a connected video source, but not of keyboard and mouse.

HARDWARE

FRONT PANEL (cont.)

Function of buttons



- **BUTTON 1 to 4** Press these buttons to activate the corresponding channel (computer port) for keyboard and mouse access and switch to Fullscreen Mode, if Quad Mode is in operation.
In Fullscreen Mode the PiP function is not affected.
- **QUAD BUTTON** Press this button to activate Quad Mode or return to fullscreen of last selected channel.
- **PiP BUTTON** In Fullscreen Mode this button is used to enable or disable the PiP (picture in picture) function.

In Quad Mode the PiP button is used to open the channel selection window, where the blue selector points to the active channel. In order to select another channel press this button repeatedly.

After the expiration of channel selection timeout on a selected computer, the channel selection window disappears.
The channel selection timeout is configured in OSD under „System -> Quad Mode“. Set the channel timeout to a value from 1 to 30 seconds.

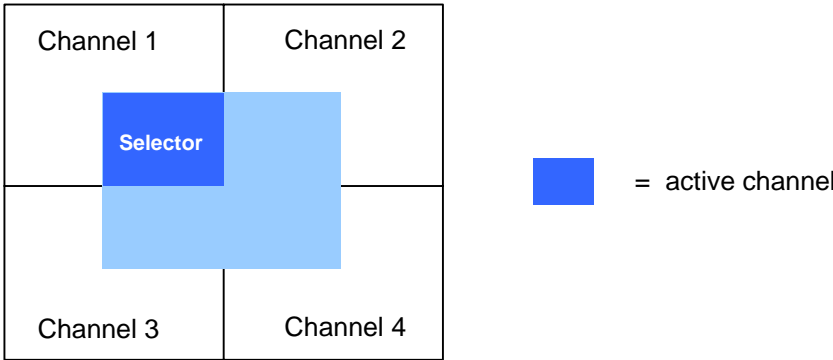

Channel selection window

Note:
Hotkey P in Quad Mode does the same operation as the PiP button.

INTRODUCTION

HARDWARE

Additional button functions

VGA output resolution

To set output resolution to 640 x 480 pixel @ 60 Hz press buttons **1** and **2** for longer than 1 second. It is recommended to use this feature, if you can't see video on console's screen due an incorrect setting of the output resolution. After configuration to this basic settings use OSD in order to set a valid video format (resolution + rate) for the connected monitor.



VGA Resolution
640 x 480 px

Hardware Reset

Press buttons **3** and **4** simultaneously for longer than 4 seconds in order to reset the unit completely (video + mouse + keyboard) - see also page 5: Reset.

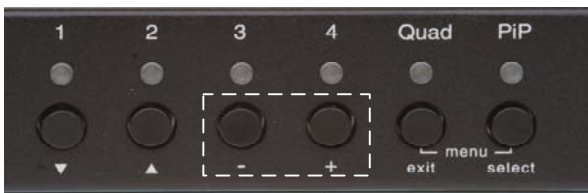

Hardware
Reset

Note:

By switching power off and on, the device resets only the video circuit due to the „keep alive“ function of keyboard and mouse.

Entry OSD

Press buttons **Quad** and **PiP** simultaneously for longer than 1 second in order to display the OSD menu .



OSD
menu

HARDWARE

REAR PANEL

All cables are connected at the rear panel as shown below. There are connectors for power, serial, console and computers.

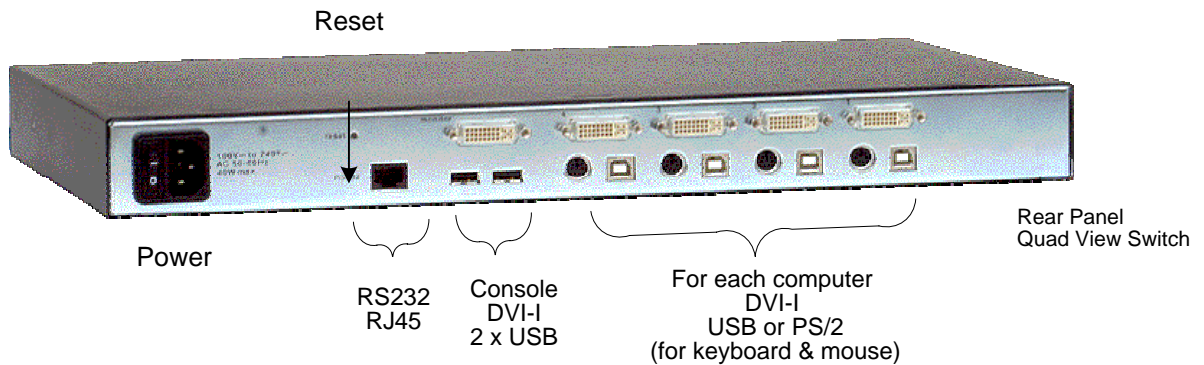

POWER Plug for power cord

RESET Button

By pressing this button the V-Switch quad will be reset completely (video, keyboard and mouse).

Note: By switching power off and on the device resets only the video circuit due to the „keep alive“ function of keyboard and mouse. If there is a problem with mouse or keyboard it is recommended to execute a RESET (Reset button at rear side or buttons 3 and 4 on front side).

RS 232 RJ - 45- Plug connector

Serial RS 232 - port is used to load flash firmware updates to the unit.

INTRODUCTION

HARDWARE

REAR PANEL

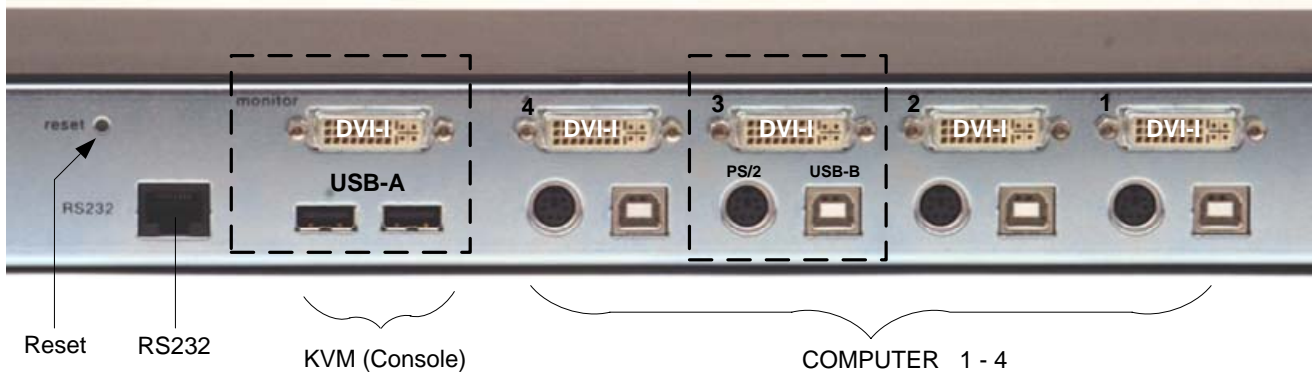

KVM (Keyboard/Video/Mouse) DVI-I USB-A USB-A

USB-A ports are used for connecting keyboard and mouse, Using a USB Hub you can connect a couple of keyboards and mice. They will work in share mode with an inactivity timeout of 3 seconds.
DVI-I port is used for VGA/DVI monitor connection.

COMPUTER 1 – 4 DVI-I PS/2 (Multi) USB-B

For keyboard and mouse connection between Quad View Switch and computer use either PS/2 plus Y or USB cables.

Using a USB-Hub, you can connect couples of keyboards or mice to Quad View Switch's USB connector. They will work in share mode with an inactivity timeout of 3 seconds.

REMOTE OPERATION

If necessary (depending on distance, quality, infrastructure etc.) you can use LINDY's KVM - Extender on KVM port in order to work remotely over CAT5, fiber optic or ethernet .

INSTALLATION

Quad View Switch is best located as close as possible to the computers that are attached to it. This reduces the length of cables and provides a more cost effective installation. Quad View Switch may also be mounted in a 19" rack with the optional rack mount kit.

Keyboard, monitor and mouse (console) are connected to the Quad View Switch with corresponding cables (DVI, USB or PS/2). For longer distances there are diverse KVM extenders available (fiber, copper or IP).



Connecting power to the unit

- Plug the power cable into the power plug located on the back of the Quad View Switch, but do not turn the power on yet.

Connecting console (keyboard, video monitor and mouse)

- Connect your monitor directly into unit's DVI-I plug with VGA to DVI-I cable (analog) or DVI cable (digital).
- Connect your USB- keyboard and mouse to the corresponding connectors (USB-A). For PS/2 keyboard and mouse or KVM extender use the attached PS2-USB adapter.

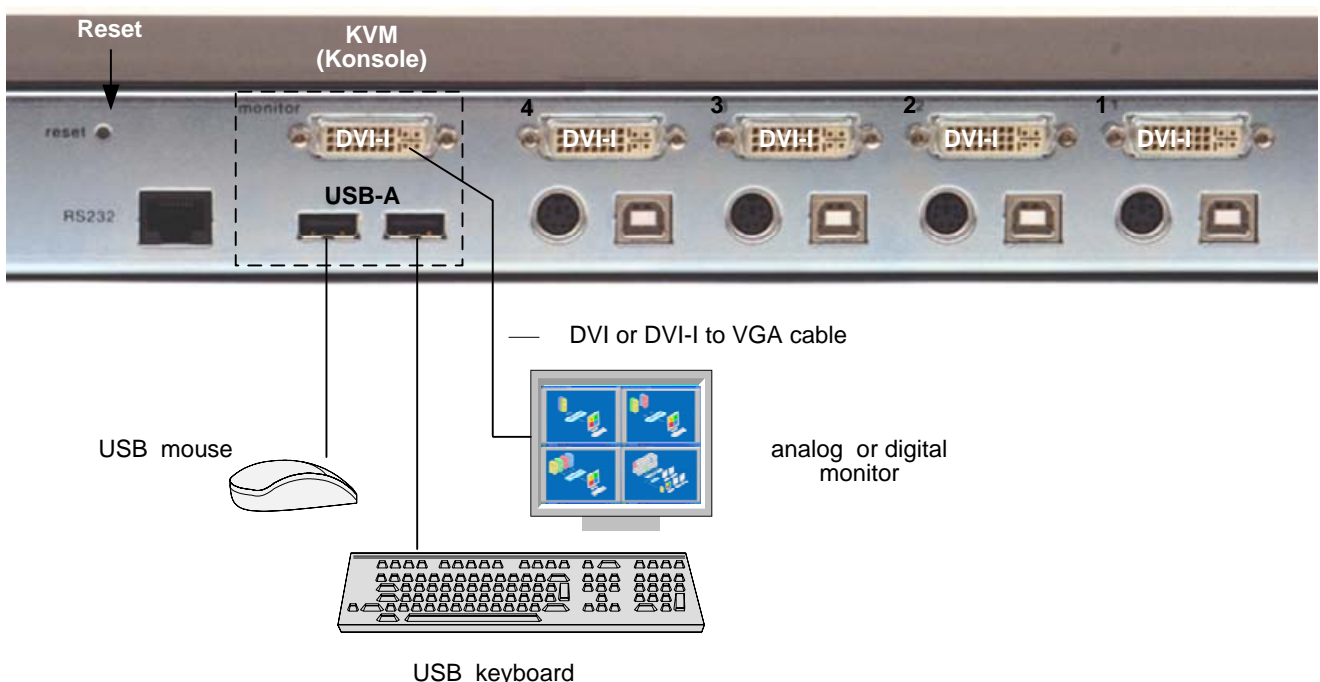

INSTALLATION

INSTALLATION

Connecting the computers

- Disconnect the keyboard, monitor and mouse from a computer after it has been switched off.
- Connect keyboard and mouse either with a single USB cable to USB-B connector or connect them with two PS/2 cables and a Y cable to the common PS/2 connector (see below).
- Connect an analog computer video source (VGA) with a VGA to DVI-I cable. Digital video sources are connected via DVI cable.

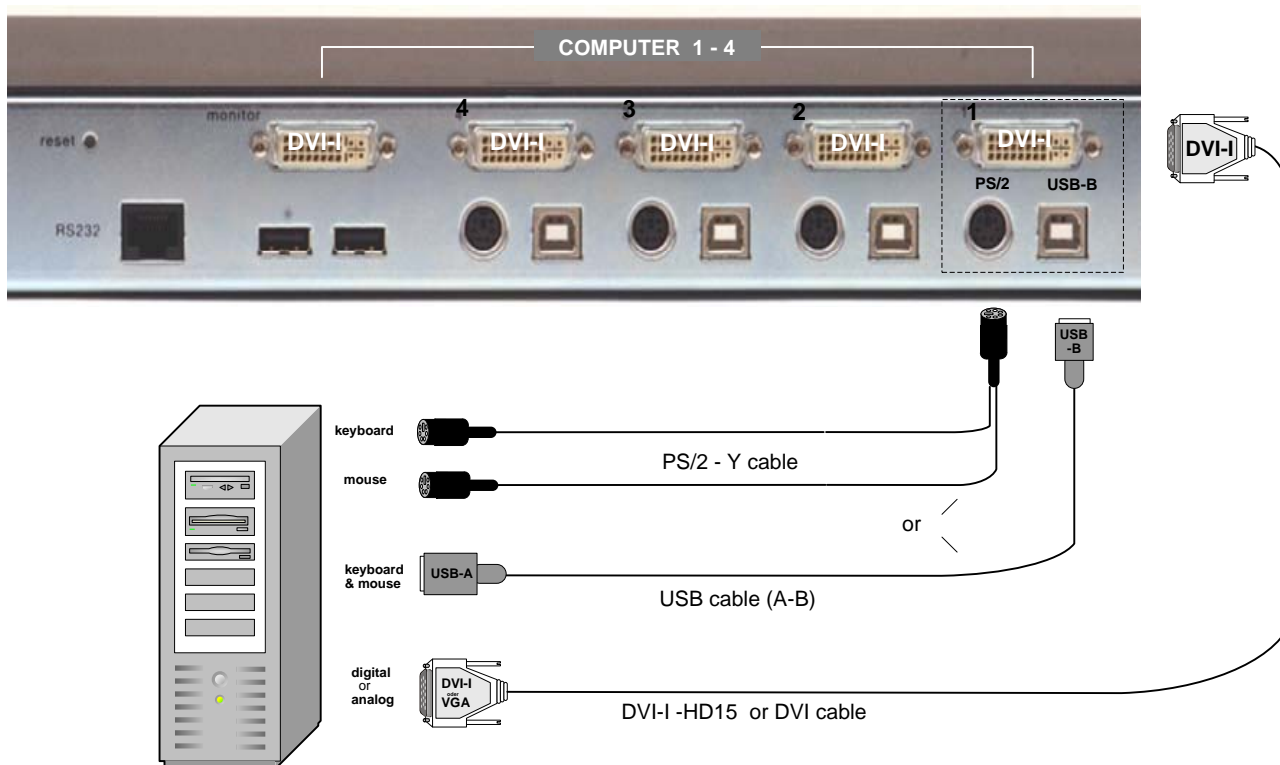

Powering up the system

- Power up Quad View Switch. At first all six LEDs will flash for a short time, then the green QUAD LED indicates that the unit is ready for operation in Quad Mode (factory default).
- Power up all connected computers. Quad View Switch recognizes all input video sources and displays them all on your monitor screen.
- To change the display mode use the relevant keyboard commands (see pages 9-12) or push buttons (see page 3,4 and 13).

Configuration

Enter OSD main menu (see page 13) by either keyboard command **Hotkey O** (factory hotkey = STRG + ALT) or simultaneous pressing of **Quad** and **PiP** buttons on front of Quad View Switch for longer than one second. The main menu window pops up over the computer's video. Easy to use menus guide you through the configuration process. In chapter „OSD“ all parameter settings are described.

KEYBOARD COMMANDS

To enter a keyboard command use hotkey plus command key.

Quad View Switch supports two kinds of hotkeys you can configure in OSD : Multiple and Double Click hotkey (see page 15).

Multiple-Hotkey Command:

Press multiple keys (1 to 4, depending on configuration) plus command key

COMMAND = Hotkey  +  together

there are following hotkeys available for selection :

left **CTRL**, **SHIFT**, **ALT** und **WINDOWS**

Examples: **HOTKEY**  =  +  + 

 =  + 

 =  + 

Double Click-Hotkey Command:

Double click one key (= Hotkey) and afterwards command key within 2 seconds.

COMMAND = Hotkey  →  one after the other

for double click hotkey you can choose one of the following keys:

left **CTRL**, **SHIFT**, **ALT** and **SCROLL LOCK**

Examples: **HOTKEY**  =   (press key twice)

 =  

Note :

In command mode (hotkey is activated) two LEDs on keyboard are blinking. In this state the unit is prepared to receive a valid command.

KEYBOARD COMMANDS

KEYBOARD COMMANDS - Multiple Hotkey Commands

Selection of Display Mode

HK + **Q** **Quad Mode**

When you simultaneously press hotkey and command key **Q**, unit switches to Quad Mode or back to last selected fullscreen channel.

HK + **F** **Fullscreen Mode**

When you simultaneously press hotkey and command key **F**, unit switches to Fullscreen Mode.

HK + **P** **PiP Function (Fullscreen) / Select Channel (Quad)**

When you simultaneously press hotkey and command key **P** in Fullscreen Mode, unit enables or disables PiP (picture in picture) function. In Quad Mode the Hotkey P is used to open the channel selection window, where the blue selector points to the active channel. In order to select another channel press Hotkey P repeatedly.

Computer Selection

HK + **1** **Computer 1 (Fullscreen)**

HK + **2** **Computer 2 (Fullscreen)**

HK + **3** **Computer 3 (Fullscreen)**

HK + **4** **Computer 4 (Fullscreen)**

When you simultaneously press hotkey and command key **1, 2, 3** or **4**, unit switches the corresponding computer to Fullscreen Mode and enables keyboard and mouse access.

Switch to Quad Mode and activate a channel's keyboard and mouse

HK + **F1** **Computer 1**

HK + **F2** **Computer 2**

HK + **F3** **Computer 3**

HK + **F4** **Computer 4**

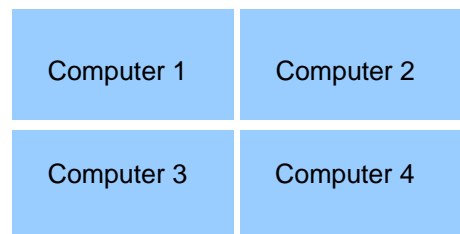

Quad screen

When you press hotkey and command key **F1, F2, F3** or **F4** simultaneously, unit switches to Quad Mode and enables keyboard and mouse access to the corresponding computer.

KEYBOARD COMMANDS - Multiple Hotkey Commands

Additional commands



When you simultaneously press hotkey and command key **O**, unit enters and displays OSD (see Chapter On Screen Display)



When you simultaneously press hotkey and command key **V** for longer than 5 seconds, unit sets output video resolution to 640x 480 pixel at 60 Hz (basic video settings).



When you simultaneously press hotkey and command key **I**, unit enters PIP menu directly

KEYBOARD COMMANDS - Double Click Hotkey Commands

Selection of Display Mode



When you press hotkey and afterwards command key **Q**, unit switches to Quad Mode or back to last selected fullscreen channel.



When you press hotkey and afterwards command key **F**, unit switches active channel to Fullscreen Mode.



When you press hotkey and afterwards command key **P** in Fullscreen Mode, unit enables or disables PiP (picture in picture) function.
In Quad Mode the Hotkey **P** is used to open the channel selection window, where the blue selector points to the active channel. In order to select another channel use Hotkey **P** repeatedly.

KEYBOARD COMMANDS

KEYBOARD COMMANDS - Double Click Hotkey Commands

Computer Selection

HK → 1 **Computer 1 (Fullscreen)**

HK → 2 **Computer 2 (Fullscreen)**

HK → 3 **Computer 3 (Fullscreen)**

HK → 4 **Computer 4 (Fullscreen)**

When you press hotkey and afterwards command key **1, 2, 3** or **4**, unit switches the corresponding computer to Fullscreen Mode and enables keyboard and mouse access.

Switch to Quad Mode and activate a channel's keyboard and mouse

HK → F1 **Computer 1**

HK → F2 **Computer 2**

HK → F3 **Computer 3**

HK → F4 **Computer 4**

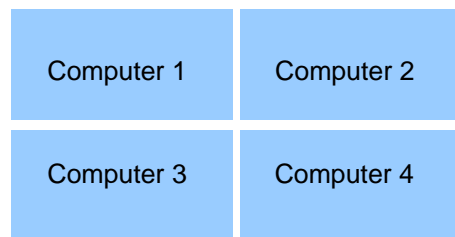

Quad screen

When you press hotkey and afterwards command key **F1, F2, F3** or **F4**, unit switches to Quad Mode and enables keyboard and mouse access to the corresponding computer.

Additional commands

HK → O **Display OSD**

When you press hotkey and afterwards command key **O**, unit enters and displays OSD (see Chapter On Screen Display)

HK → V **Basic output resolution**

When you press hotkey and afterwards command key **V** for longer than 5 seconds, unit sets output video resolution to 640x 480 pixel at 60 Hz (basic video settings).

HK → I **Enter PiP Menu**

When you press hotkey and afterwards command key **I**, unit enters PIP menu directly

MAIN MENU

There are two ways to display the main menu:

1. use Keyboard Command **O** (see page 9 & 10) or
2. simultaneously press **Quad** and **PiP** buttons on front of Quad View Switch for longer than one second.

The main menu window pops up over video. Easy to use menus guide you through the configuration process.

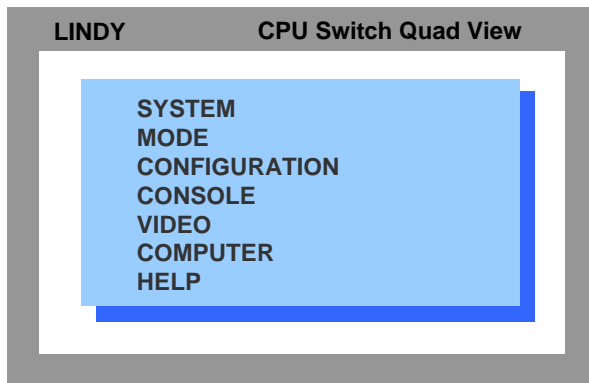

↑ ↑
Enter OSD

NAVIGATION

Using the on-screen display is very easy and simple to use. You can navigate either via buttons on front panel or keys on your keyboard.

a. Navigating with keyboard :

To navigate up and down in the OSD or to go from one field to the next (when relevant) use the UP and DOWN arrow keys or the Tab key. Use the LEFT and RIGHT arrows or + (Plus) or - (Minus) key, in order to change the value in the current field. To exit the OSD or return to a previous window within the OSD press ESC. Press ENTER to select an operation or enter a submenu.

b. Navigating with Front panel buttons:



← Equivalent to keyboard button

To navigate up and down in the OSD or to go from one field to the next (when relevant) use the front panel buttons **1** and **2**. Using the **3 (-)** or **4 (+)** button, you can change the value in the current field. To exit the OSD or return to a previous window within the OSD press button **QUAD**. Press **PiP** to select an operation or enter a submenu. Configuration will automatically be stored.

Note: When the OSD is activated you cannot select display modes using the front panel buttons or normal keyboard commands. In order to switch between display modes (Quad / Full / PiP), the hotkey is replaced by the CTRL key.

ON SCREEN DISPLAY

OSD - MENU STRUCTURE

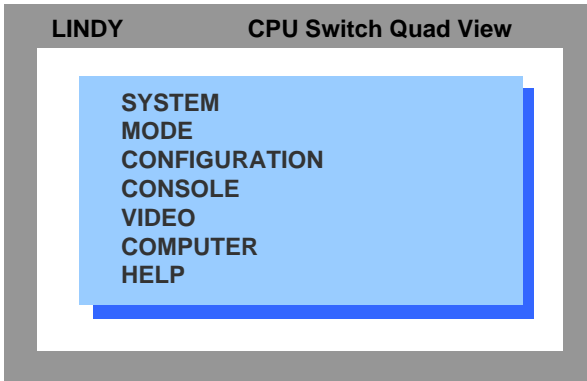

OSD - MENU STRUCTURE

SYSTEM	HOTKEY HOTMOUSE QUAD MODE OSD POSITION OSD LANGUAGE SECURITY TEST PATTERN DISABLE CHANNEL	Multiple Hotkey / Double Click Hotkey Hotmouse Recognition / Timeout for Hotmouse Timeout for Channel Selection Position of OSD-Window English / German Set security level (0, 1 – 8) Crosshairs - Color gradient – Rhombus - Rectangle - Stripes Inactivate unused channels
MODE	PIP START	Size, zoom, position, display mode of PIP Set Start Configuration
CONFIGURATION	SAVE RECALL DEFAULTS	Save current parameters Restore last saved configuration Reset to factory default settings
CONSOLE	VIDEO OUTPUT KEYBOARD MULTI MONITOR EDID	Output resolution (auto or selection from list) Keyboard layout (English, German) Assigning mouse & keyboard to video Display EDID data of monitor
VIDEO	VIDEO INPUT BRIGHTNESS CONTRAST HORIZ POSITION VERT POSITION SCREEN WIDTH PHASE FORMAT	Show computers' video input formats Set input signal to: DVI, VGA, VGA-DVI or DVI-VGA Set brightness of analog input signal Set contrast of analog input signal Horizontal screen position Vertical screen position Set screen width of analog input signal Adjust phasing of analog input signal Fit input format to screen
COMPUTER	KEYBOARD MOUSE RESET PS/2	Display type of keyboard (PC1, PC2, PC3 or USB) Display type of mouse (PS/2, PS/2 Wheel or USB) Reset PS/2 mouse and keyboard
HELP	COMMAND ABOUT CONTACT	List of keyboard commands Revision Level - Firmware / Hardware Contact Information

OSD - SYSTEM

HOTKEY

Use arrow keys to navigate in SYSTEM menu to the HOTKEY line and press Enter / select to open the Hotkey window.

As described in section „Keyboard Commands“ (page 9), two different hotkey modes are available:

- For **multiple hotkey** configure 1 to 4 keys, which are pressed simultaneously.
Selectable keys are: CTRL, SHIFT, ALT and WINDOWS.
- For **double click hotkey** define one key, which is pressed twice within 1 second.
Selectable key is: CTRL, SHIFT, ALT or SCROLL LOCK.

To modify the hotkey mode or keys navigate with arrow keys to the desired field and change it with +/- keys.

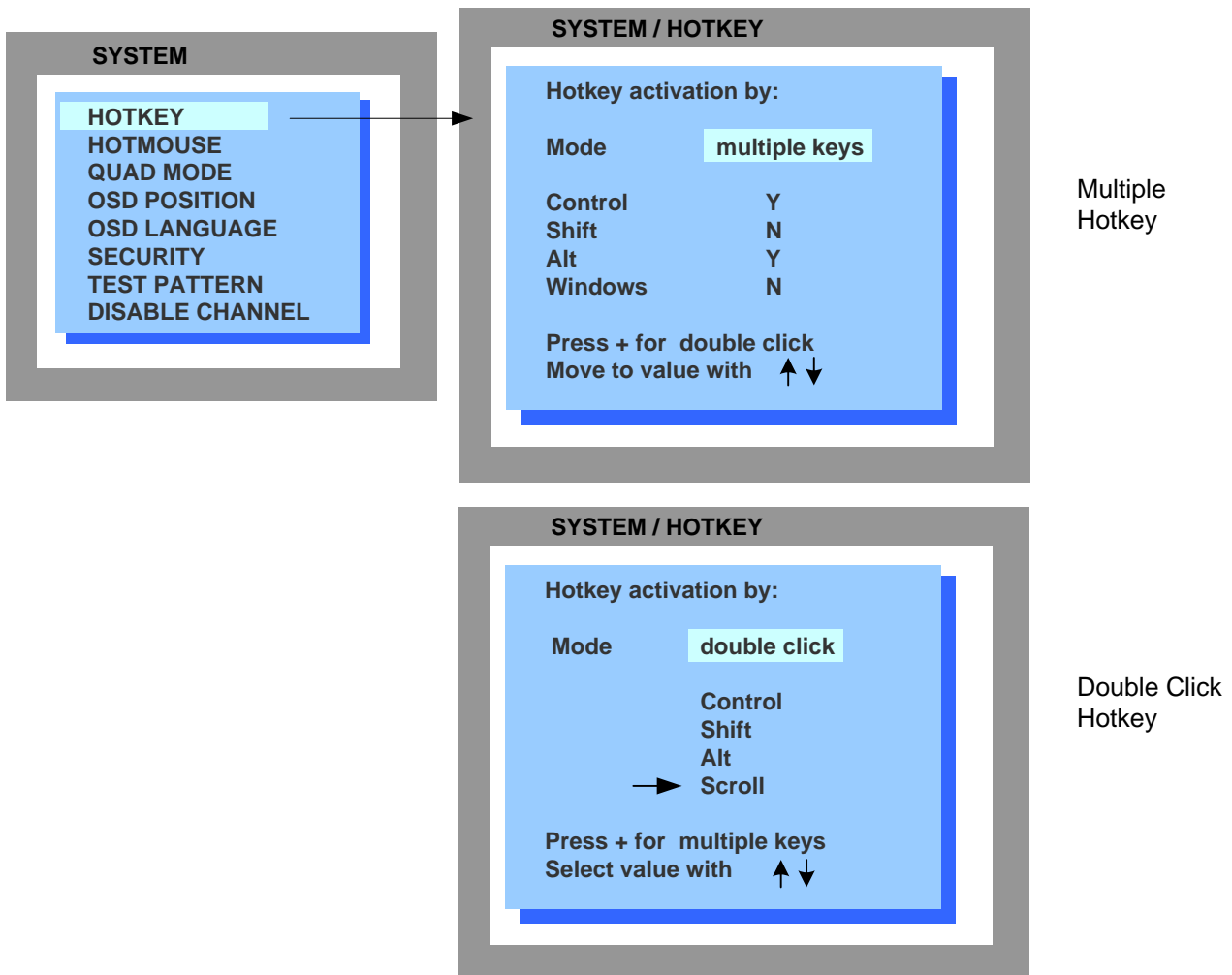

Note:

In normal operation two LEDs on console keyboard are blinking if the configured hotkey is pressed.
Default : Multiple Hotkey : CTRL + ALT

OSD - SYSTEM - HOTMOUSE

HOTMOUSE OPERATION

Use arrow keys to navigate in SYSTEM menu to the HOTMOUSE line and press Enter / select to open the Hotmouse window.

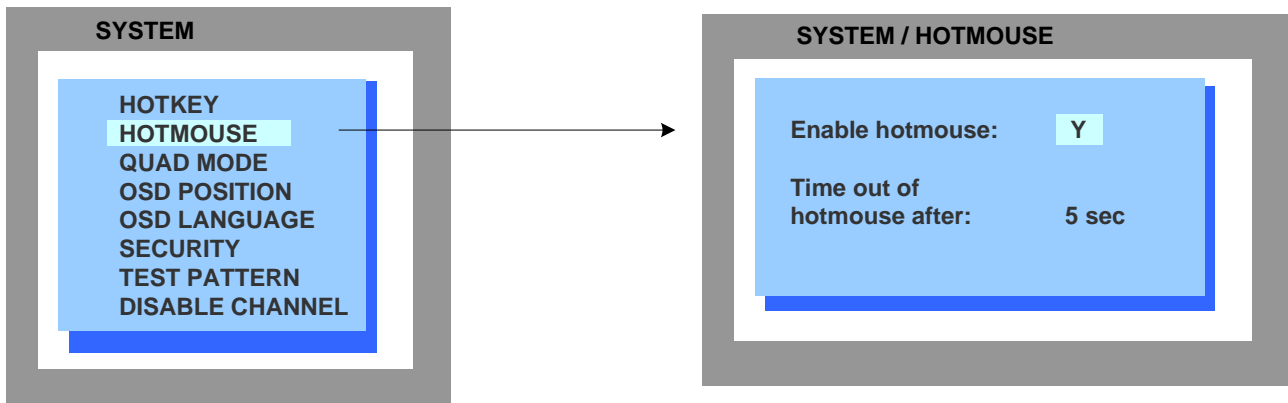

In order to activate hotmouse operation, navigate to „Enable Hotmouse“ line and set „Y“ for yes.

The hotmouse function differentiates between two modes: **Hotmouse Cursor** and **Hotmouse Menu**. The Hotmouse Cursor supports only a limited set of operations. The Hotmouse Menu in contrast allows you to execute all display mode switch operations, setting of active channel and different PiP settings.

HOTMOUSE CURSOR ACTIVATION

To activate **Hotmouse Cursor**, move the mouse rapidly in alternating horizontal direction four times.

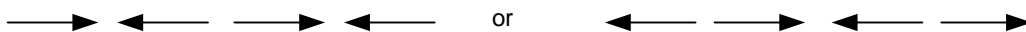

The hotmouse cursor may change its look depending position on screen (arrows in vertical or horizontal direction and number (1-4) of channel).



Hotmouse Cursor

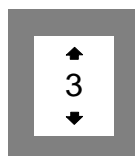

Vertical positioning of PiP images

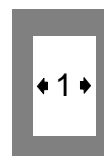

Modify size of PiP images

Using hotmouse cursor you can execute the following functions:

- in Fullscreen Mode: - Switch to another fullscreen channel
- in Quad Mode: - Set active channel (keyboard, mouse)
- in PiP Mode: - Modify position and size of PiP images
- Exchange active channel (Fullscreen)

OSD - SYSTEM - HOTMOUSE

HOTMOUSE CURSOR IN FULLSCREEN MODE

Activating Hotmouse cursor in Fullscreen Mode, PiP images of the other channels are temporarily displayed in order to switch to another channel.

Switching to another fullscreen channel

Activate hotmouse cursor. Move hotmouse cursor over that PiP image of the channel that should be activated and displayed in fullscreen and press left mouse button.

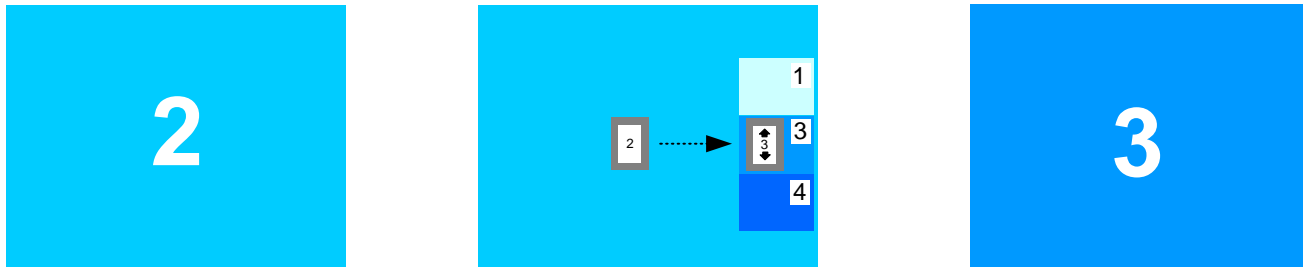

Example: Switch fullscreen channel from 2 to 3

HOTMOUSE CURSOR IN QUAD MODE

Switching active channel (keyboard, mouse)

Activate hotmouse cursor. Move hotmouse cursor to desired channel field (1 to 4) and press the left mouse button in order to switch mouse and keyboard operation to this channel.

Note: The number in the hotmouse cursor changes when moving over different channels.

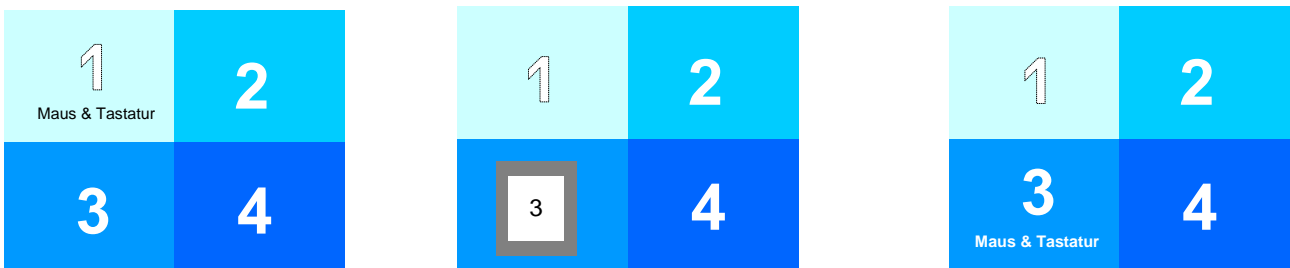

Example: Switch active channel from 1 to 3

OSD - SYSTEM - HOTMOUSE

HOTMOUSE CURSOR IN PiP MODE

Exchange active fullscreen channel

Activate hotmouse cursor. Move hotmouse cursor to desired PiP image of the channel that should be exchanged and press left mouse button.

Note: As soon as hotmouse cursor moves over PiP images it changes the look (arrows, channel number)

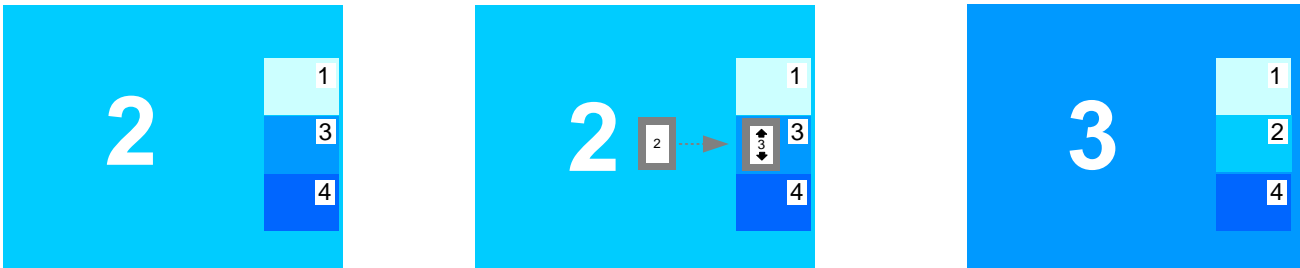

Example: Exchange active fullscreen channel from 2 to 3

Vertical positioning of PiP images

Activate hotmouse cursor. Move hotmouse cursor over PiP image area, hold left mouse button pressed and move PiP image area (one or more PiP images) to the desired vertical position.

Note: As soon as hotmouse cursor moves over PiP images it changes the look (arrows, channel number)

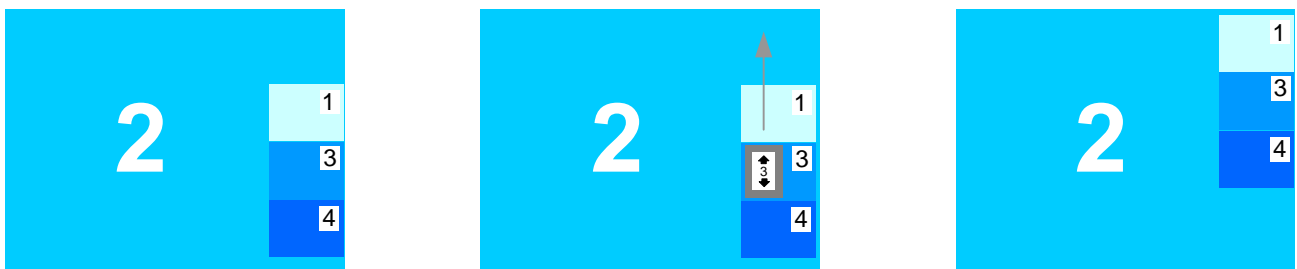

Example: Move PiP images to an upper position

OSD - SYSTEM - HOTMOUSE

HOTMOUSE CURSOR IN PiP MODE (continued)

Modify size of PiP images

Activate hotmouse cursor and move it to the left edge of PiP image area. When horizontal arrows appear in hotmouse cursor, press the left hand mouse button. Hold it pressed and move the hotmouse cursor left or right in order to scale the size of PiP images up or down.

Scaling PiP images up

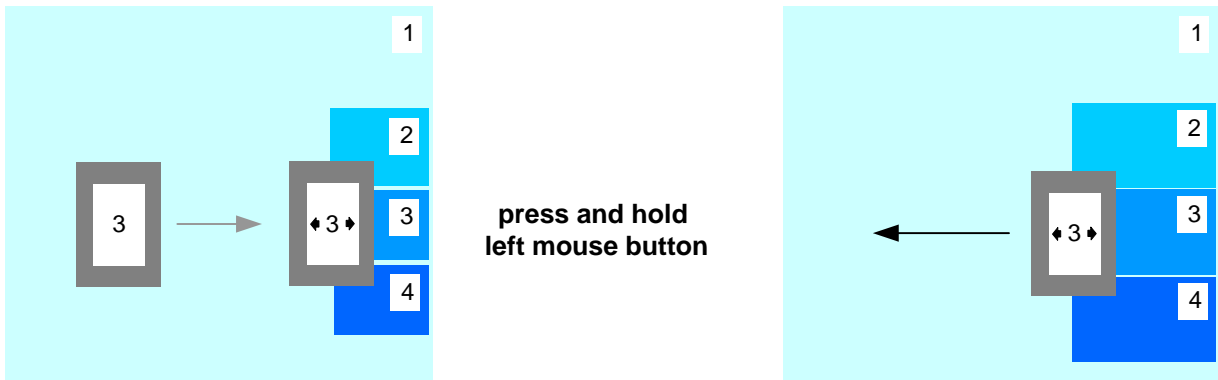

Scaling PiP images down

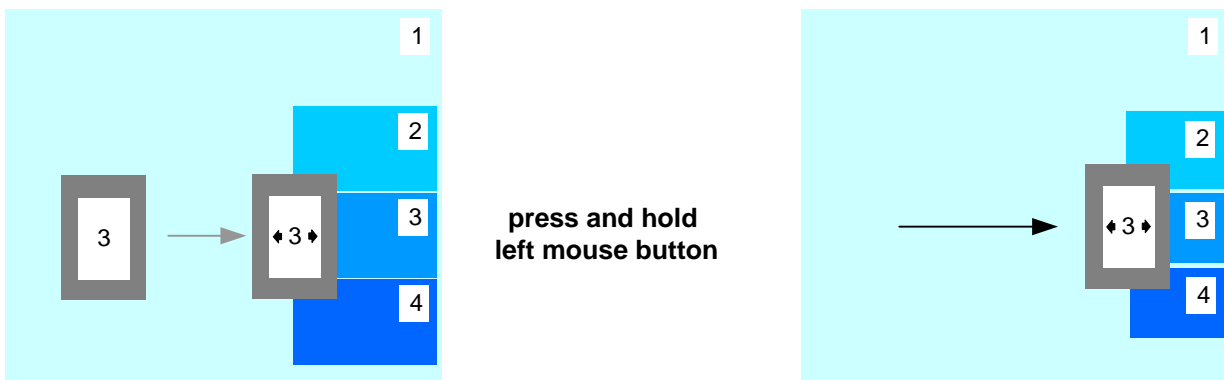

OSD - SYSTEM - HOTMOUSE

HOTMOUSE MENU ACTIVATION

Activate hotmouse cursor and press the **right** mouse button. This opens the Hotmouse menu. Depending on display mode setting (Quad / Full / PiP) the look of hotmouse menu is different.

Available operations:

- in Fullscreen Mode:
 - Switch to another fullscreen channel
 - Switch to another display mode (Quad / Fullscreen / PiP)
- in Quad Mode:
 - Switch to another channel
 - Switch to another display mode (Quad / Fullscreen / PiP)
 - Select active channel
- in PiP Mode:
 - Exchange active channel
 - Switch to another display mode (Quad / Fullscreen / PiP)
 - Modify position and size of PiP images and PiP zoom
 - Select PiP Mode (triple / triple gap / single fixed / single direct / single scan) and scan time

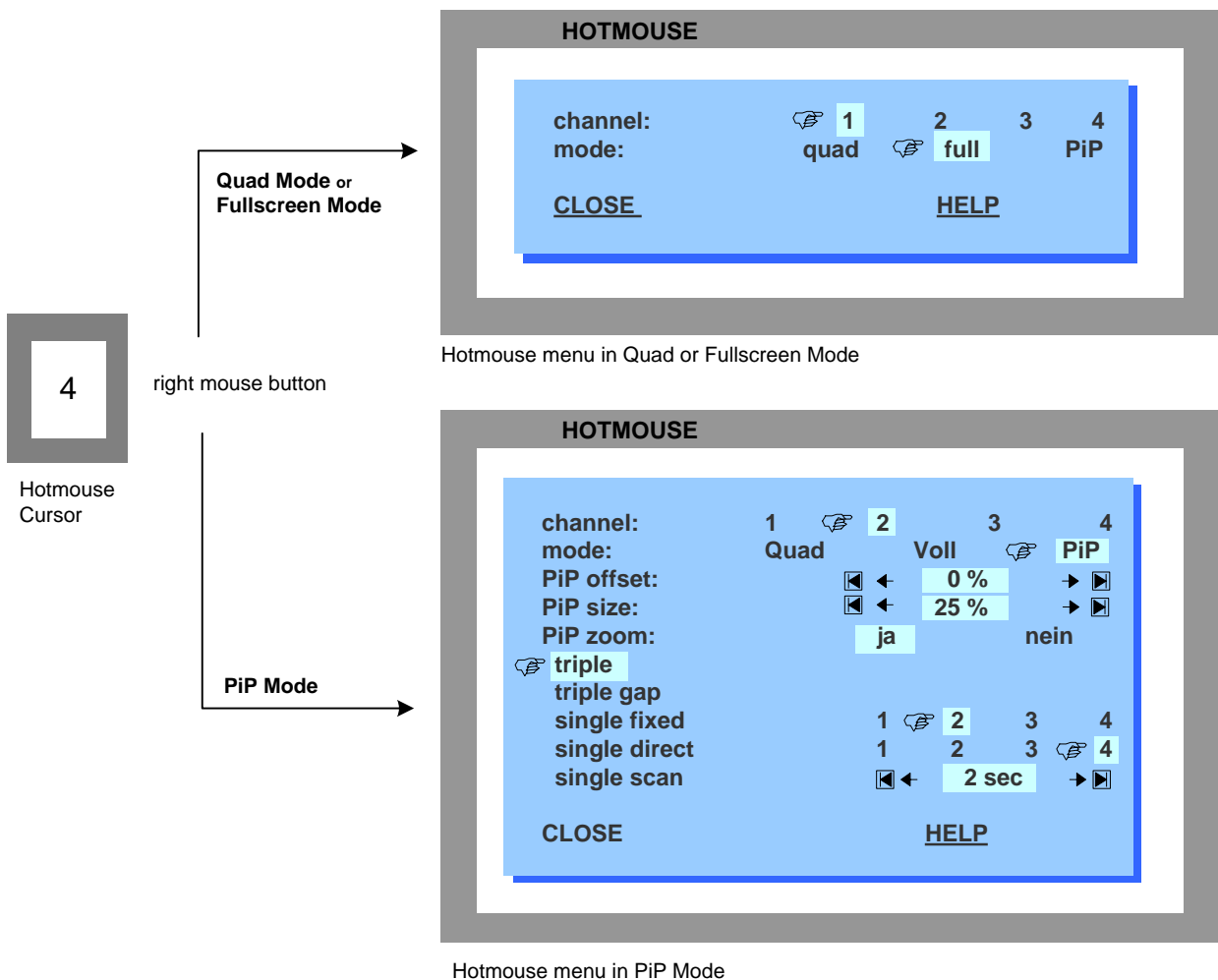

OSD - SYSTEM - HOTMOUSE

HOTMOUSE MENU

Using hotmouse menu you can execute all possible switch operation combinations (display mode / active channel) and modify PiP settings. To open the hotmouse menu activate hotmouse cursor and press **right** mouse button.

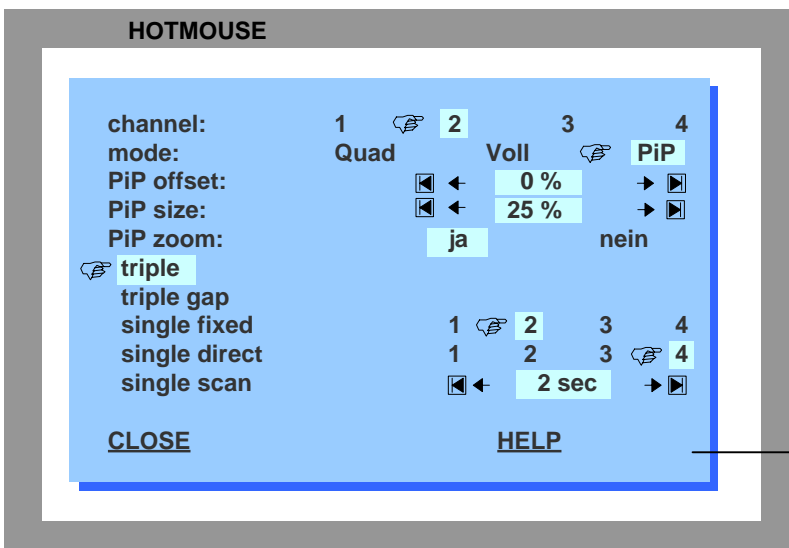





The hand symbol  shows the actual settings of active channel, display mode and PiP settings.

Open the Hotmouse Help menu by pressing HELP button

Hotmouse menu in PiP Mode

In Hotmouse Help window the function of different symbols are described

By pressing left hand mouse button on arrows   the values are increased or decreased, the arrow symbols   set the value to minimum or maximum value.

After your desired settings press CLOSE. All parameters are stored and menu is closed.

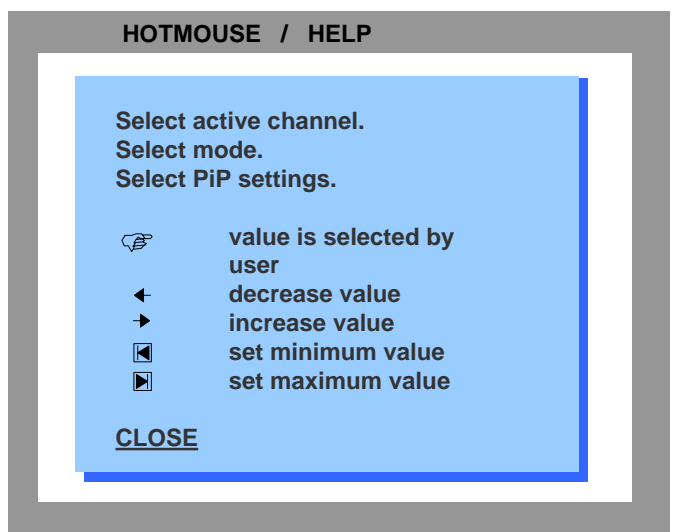

Hotmouse Help window

ON SCREEN DISPLAY

OSD - SYSTEM

QUAD MODE

Use arrow keys to navigate in SYSTEM menu to the QUAD MODE line and press Enter / select to open the Quad Mode window.

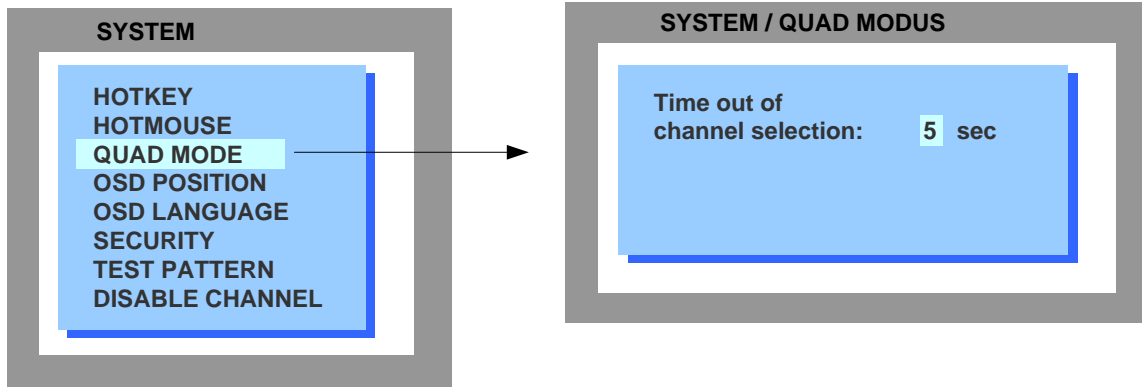

Channel selection timeout defines how long (1 to 30 sec) the Selection window is displayed in Quad Mode.

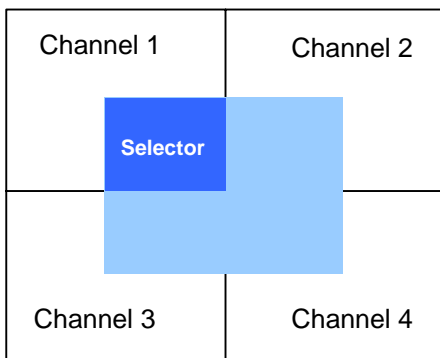

In Quad Mode the keyboard command hotkey P or the front panel PiP button opens the selection window.

The blue selector points to the active channel. In order to select another channel use hotkey P or PiP button repeatedly. This moves selector to desired channel. Press left mouse button for keyboard and mouse operation in his channel field.

After the expiration of channel selection timeout the selection window disappears.

Selection window

 = active channel

OSD - SYSTEM**OSD POSITION**

Use arrow keys to navigate in SYSTEM menu to the OSD POSITION line and press Enter / select to open the OSD Position window.

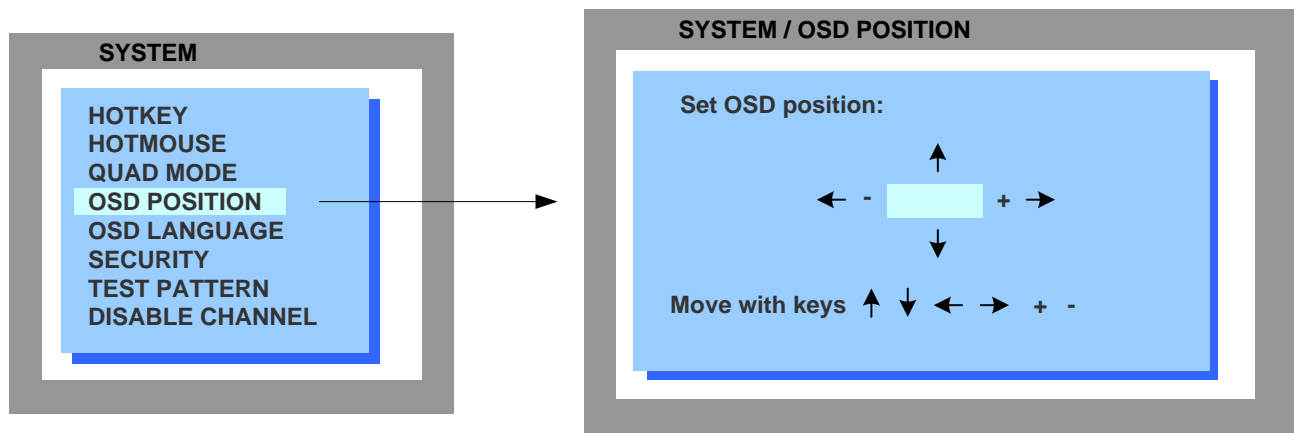

This item sets the position of the OSD window on the display screen. Use the arrow keys to move the window to any position on screen.

OSD LANGUAGE

Use arrow keys to navigate in SYSTEM menu to the OSD LANGUAGE line and press Enter / select to open the OSD Language window.

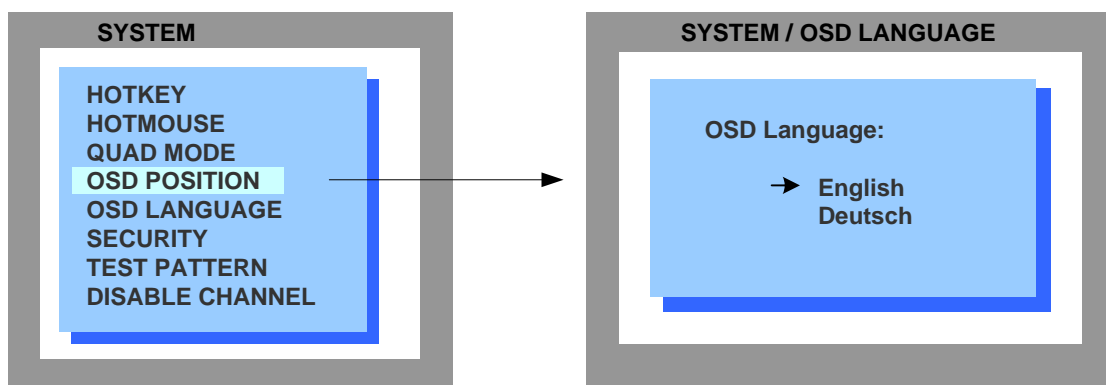

There are two languages available for the OSD: English and Deutsch (German).

ON SCREEN DISPLAY

OSD - SYSTEM - SECURITY

SECURITY - SECURITY LEVELS

Use arrow keys to navigate in SYSTEM menu to the SECURITY line and press Enter / select to open the Security window.

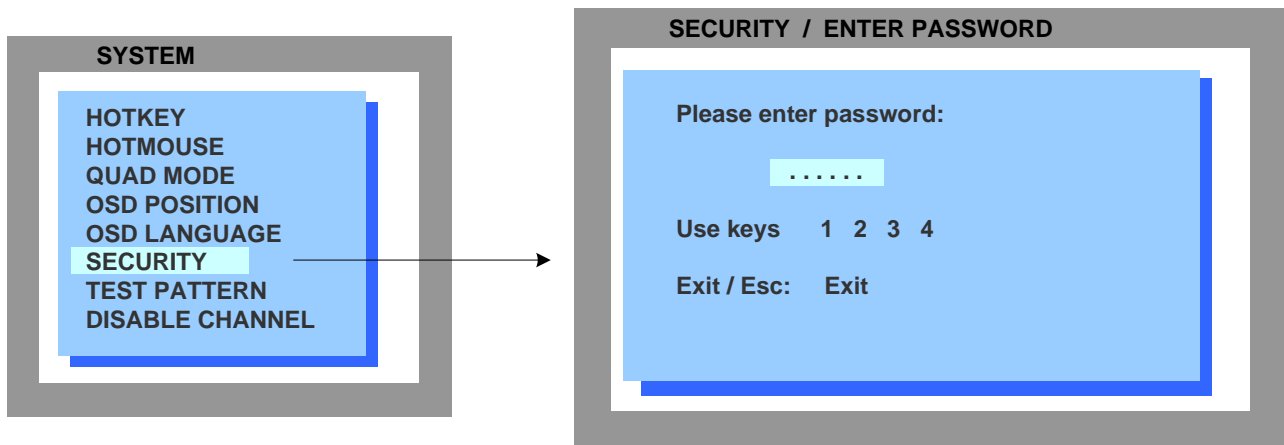

The SECURITY feature allows you to reduce the functional range of Quad View Switch's settings. There are eight security levels available.

All functions are enabled (security level 0) at delivery (factory defaults). In order to set another security level you have to enter a predefined password (see Password window). This six-digit password you'll find separate from this user manual. It should be accessible only to users like administrators etc.

After entering the password by using keyboard or front panel (keys are limited to 1 to 4) the Security window is displayed.

Set the desired security level in level-field (use digit 0 to 8, + - or arrow keys).

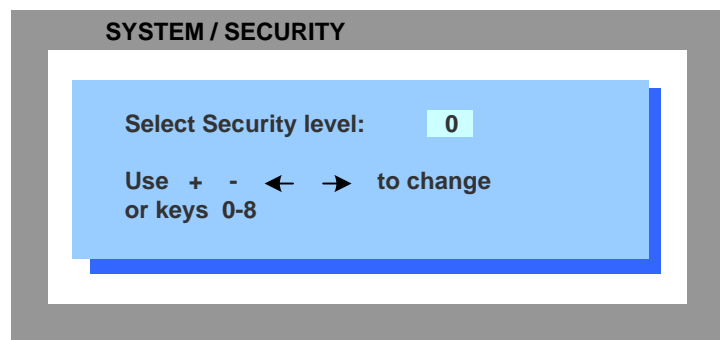

Security window.

SECURITY LEVEL 0

All functions are enabled and all settings are allowed (factory defaults).

OSD - SYSTEM - SECURITY

Note:

Before you set a security level especially to a higher level (6, 7 or 8) it is important to save your start screen with START command (see page 32) in order to restart with this screen by resetting or powering up device.

SECURITY LEVEL 8

Security level 8 (most limited level) allows you to work only on preselected channel (computer) in a predefined display mode (Quad / Full / PiP). Except the security menu, where you can change the security level there are no other operations available.

SECURITY LEVEL 7

Same as security level 8. All OSD windows are available that have information contents only (showing display modes, active channels and settings):

CONSOLE	Video Output / EDID
VIDEO	Video Input
COMPUTER	Keyboard / Mouse
HELP	Command / About / Contact

SECURITY LEVEL 6

Same as security level 7. Additionally available are:

- Active channel setting using front panel buttons, keyboard or mouse commands
- Channel selection in Quad Mode using front panel PiP button

SECURITY LEVEL 5

Same as security level 6. Additionally available are:

- Display mode setting (Quad / Full / PiP) using front panel buttons, keyboard or mouse commands

SYSTEM	Test Pattern
--------	--------------

ON SCREEN DISPLAY

OSD - SYSTEM - SECURITY

SECURITY LEVEL 4

Same as security level 5. But there are additional settings available in OSD:

SYSTEM	OSD position
MODE	PIP / Start
CONFIGURATION	Recall
VIDEO	Format

- Modify PiP settings using Hotmouse menu

SECURITY LEVEL 3

Same as security level 4. But there are additional settings available in OSD:

SYSTEM	OSD language
VIDEO	Brightness / Contrast / Horizontal position / Vertical position Screen width (analog) / Phase (analog)

SECURITY LEVEL 2

Same as security level 3. But there are additional settings available in OSD:

SYSTEM	Hotkey / Hotmouse / Quad Mode
CONSOLE	Keyboard

SECURITY LEVEL 1

Same as security level 2. Additionally available:

SYSTEM	Disable channel
CONSOLE	Multi Monitor / Video output
COMPUTER	Mouse / Reset PS/2
VIDEO	Video input

- Set video output to VGA using keyboard command (Hotkey V) or front panel buttons 1+2

OSD - SYSTEM - TEST PATTERN

TEST PATTERN

Use arrow keys to navigate in SYSTEM menu to the TEST PATTERN line and press Enter / select to open the Test Pattern window.

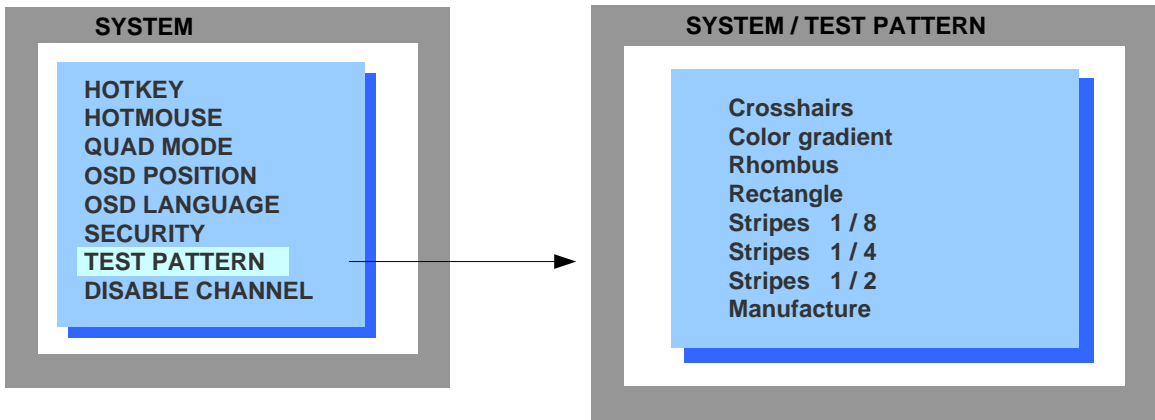

Use Test Pattern in order to check the function of internal video circuits or to check the quality of the connected console monitor. It is recommended to use all available test patterns for test procedure.

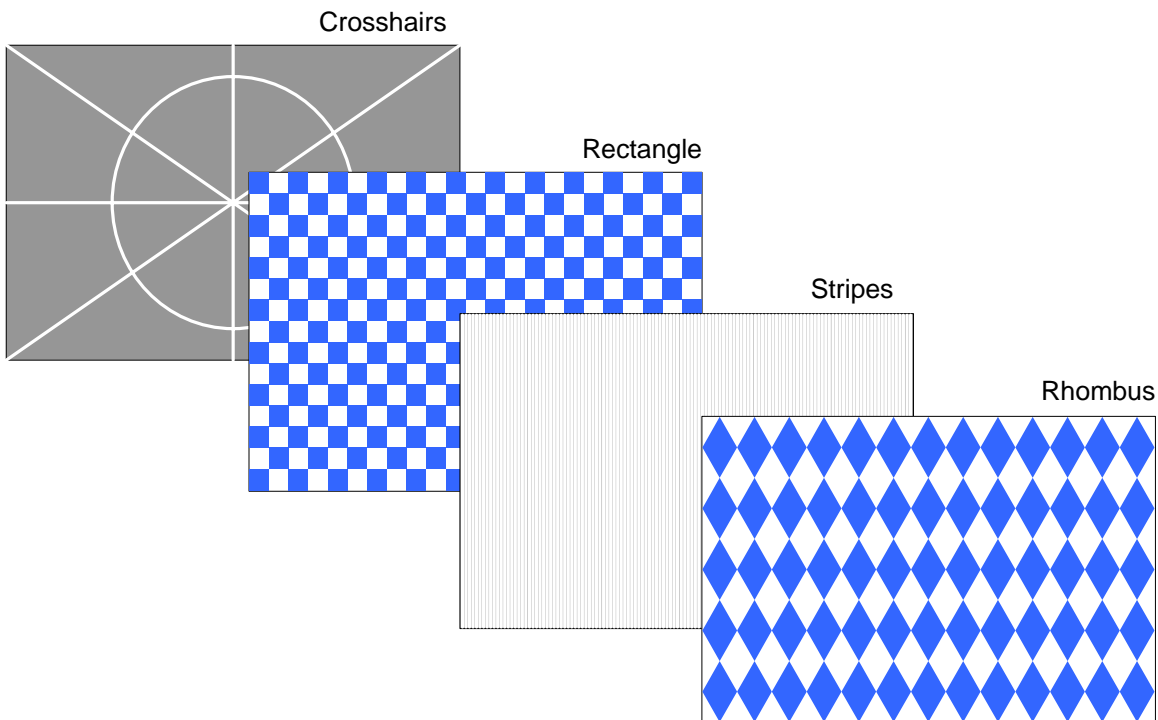

OSD - SYSTEM - DISABLE CHANNEL

DISABLE CHANNEL

Use arrow keys to navigate in SYSTEM menu to the DISABLE CHANNEL line and press Enter / select to open the Disable Channel window.

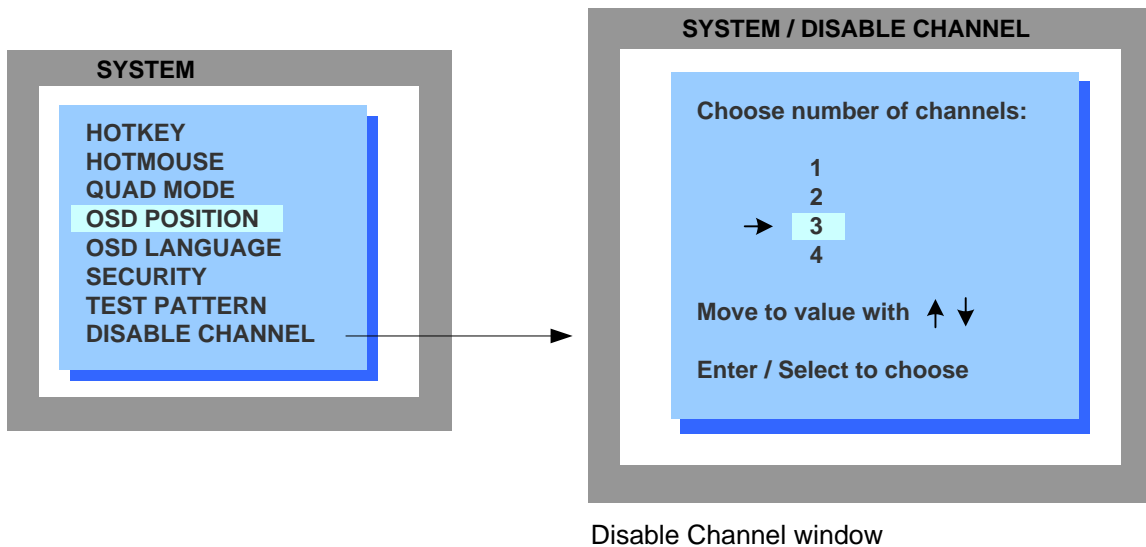

If only two or three computers or video sources are connected to Quad View Switch the „Disable Channel“ function allows you to set the number of channels to this value (2 or 3), this means:

- message „no signal input x“ is not shown in Quad Mode,
- PiP images of unconnected channels are not displayed on screen and
- in Fullscreen Mode these channels are not selectable.

If you have connected three computers (channel 1 to 3) to Quad View Switch, navigate with arrow keys to the number 3 field (see Disable Channel window) and press Enter / Select.

Note:

Using this feature, computers / video sources must be connected to Quad View Switch in ascending order from channel 1 to 4.

OSD - MODE - PIP

PIP (Picture in Picture Function)

Use arrow keys to navigate in MODE menu to the PIP line and press Enter / select to open the PiP window.

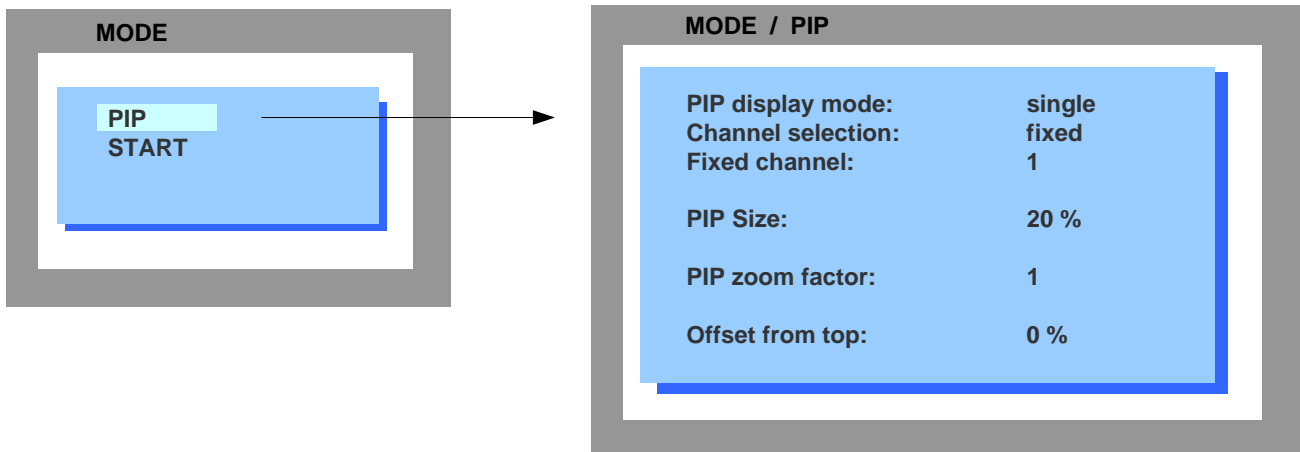

In PiP window you can configure size, zoom factor, offset from top and type of PiP display mode.

PIP size

Adjust the size of a PiP screen with this option. There are 12 different sizes available:

single: 3 % - 5 % - 7 % - 10 % - 15 % - 20 % - 25 % - 28 % - 33 % - 38 % - 44 % - 50 %
 triple: 3 % - 5 % - 7 % - 10 % - 15 % - 20 % - 25 % - 28 % - 33 %

50 % equals the size of a quad screen (a quarter of full screen).

PIP zoom factor

Using this option you have the possibility to zoom the PiP picture(s) (beginning from the center) by a factor of 2.

Offset from top

This option allows you to position the PiP picture(s) on right hand margin in vertical direction of screen.

ON SCREEN DISPLAY

OSD - MODE - PiP

PIP Display Mode

Quad View Switch offers different types of PiP display:

PIP display mode **triple** : all other three video sources are displayed (three pictures).

active channel **gap**: PiP screens are displayed with a gap for the channel currently selected in fullscreen

PIP display mode: triple
active channel: gap

active channel **no gap**: PiP screens are displayed without any gap

PIP display mode: triple
active channel: no gap

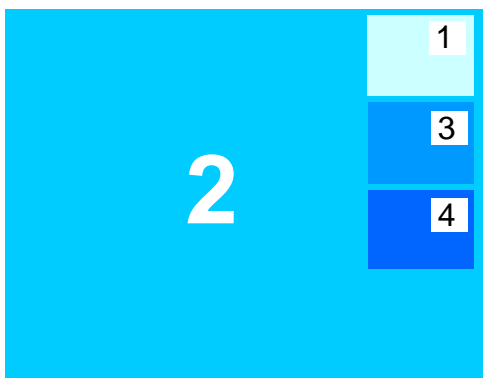

PIP display mode: triple
active channel: no gap

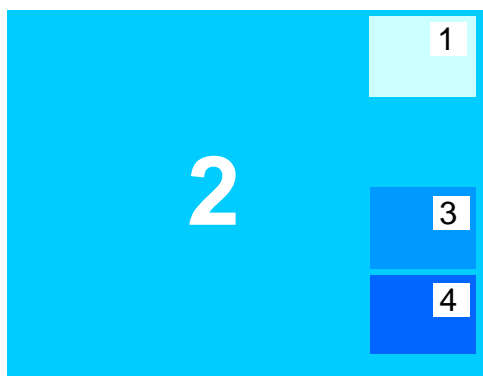

PIP display mode: triple
active channel: gap

OSD - MODE - PiP

PIP Display Mode (continued)

PIP display mode **single**: only one video source is displayed (one picture), you can choose between fixed, scan and direct channel selection:

- Single display **fixed**: the channel you select under „Fixed channel“ will be displayed in one PiP picture permanently.

PIP display mode: **single**
 Channel selection: **fixed**
 Fixed channel: **4**
- Single display **scan**: one channel after another will be displayed in one PiP picture, the scan display time can be configured between 1 and 9 seconds.

PIP display mode: **single**
 Channel selection : **scan**
 Display time: **3 sec**
- Single display **direct**: same function as „fixed mode“, but using keyboard command 1, 2, 3 or 4 or pressing front panel buttons 1 to 4 the desired channel can be selected directly.

PIP display mode: **single**
 Channel selection: **direct**
 Direct channel: **1**



PIP display mode: single
 Channel selection: fixed or direct
 Direct channel: 4

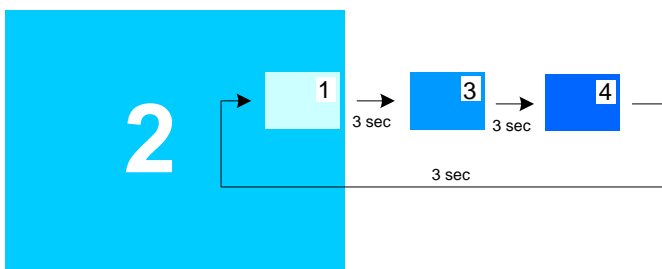

PIP display mode: single
 Channel selection : scan
 Display time: 3 sec

ON SCREEN DISPLAY

OSD - MODE - START

START (Set start configuration)

Use arrow keys to navigate in MODE menu to the START line and press Enter / select to open the Start window.

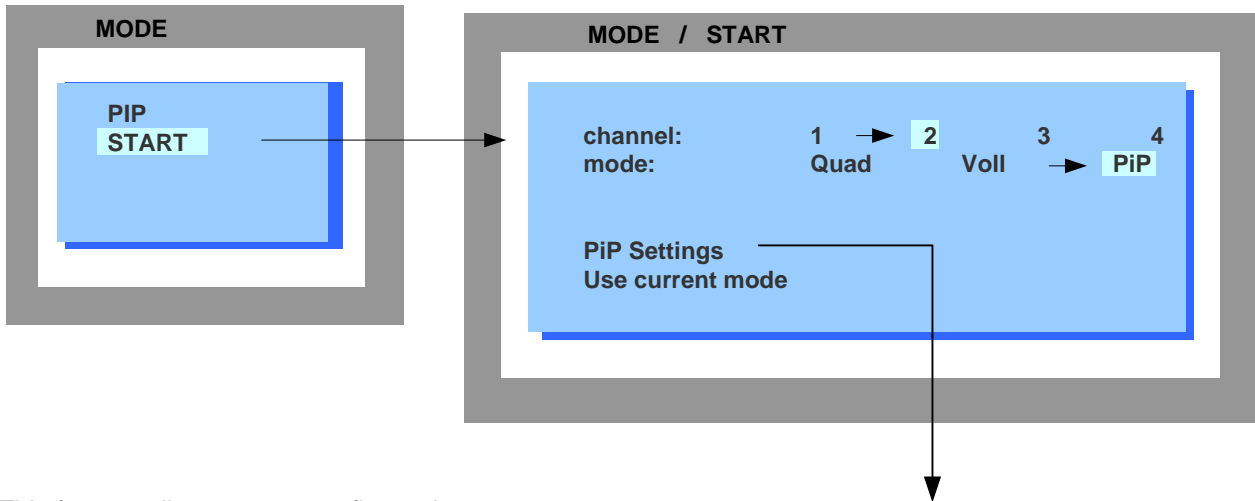

This feature allows you to configure the start configuration (display mode, active channel and PiP settings) when you reset or power up the device.

The actual Start configuration is displayed by entering the Start menu. After modifying parameters in channel, mode and PiP setting fields, press ESC key in order to save new Start configuration.

Use function „Use current mode“ in order to adopt the actual settings as Start mode. Navigate to „Use current mode“ line and confirm with Enter.

If you do not use this feature, screen comes up in Quad Mode.

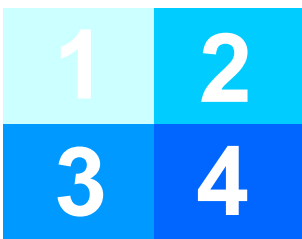
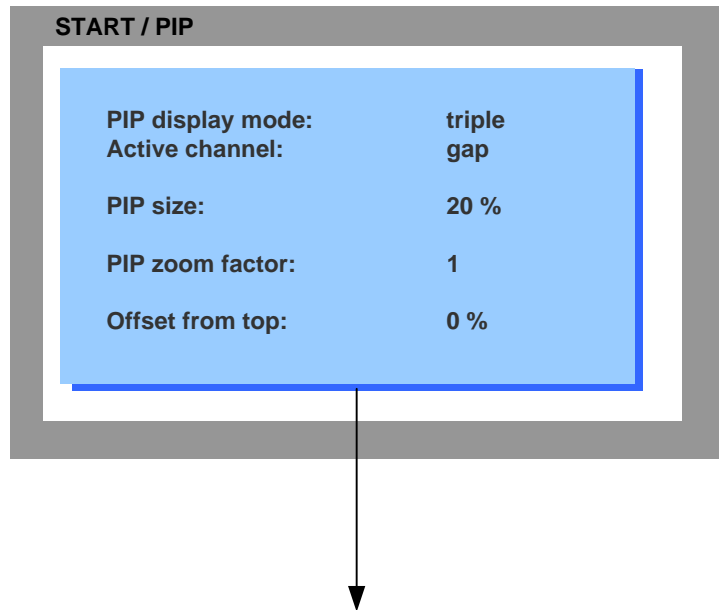

Default Start screen

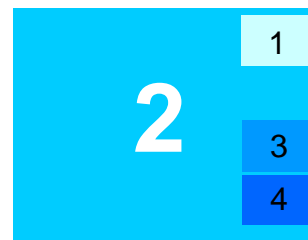

Example of a Start screen

OSD - CONFIGURATION - BACKUP

BACKUP

Use arrow keys to navigate in Configuration menu to the BACKUP line and press Enter / select to open the Backup window.

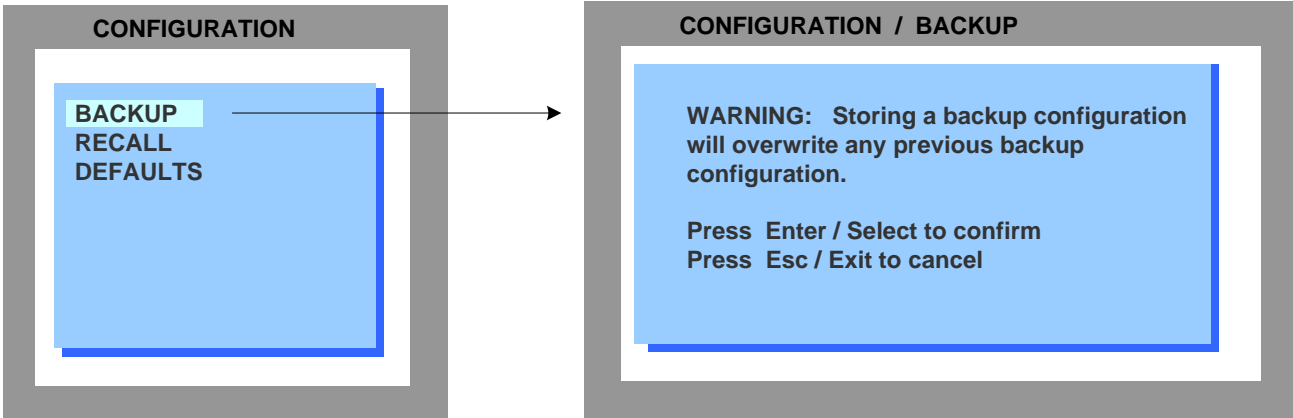

Backup command saves the actual settings permanently including „Start“ configuration (display mode, active channel and PiP settings).

OSD - CONFIGURATION - RECALL

RECALL

Use arrow keys to navigate in Configuration menu to the RECALL line and press Enter / select to open the Recall window.

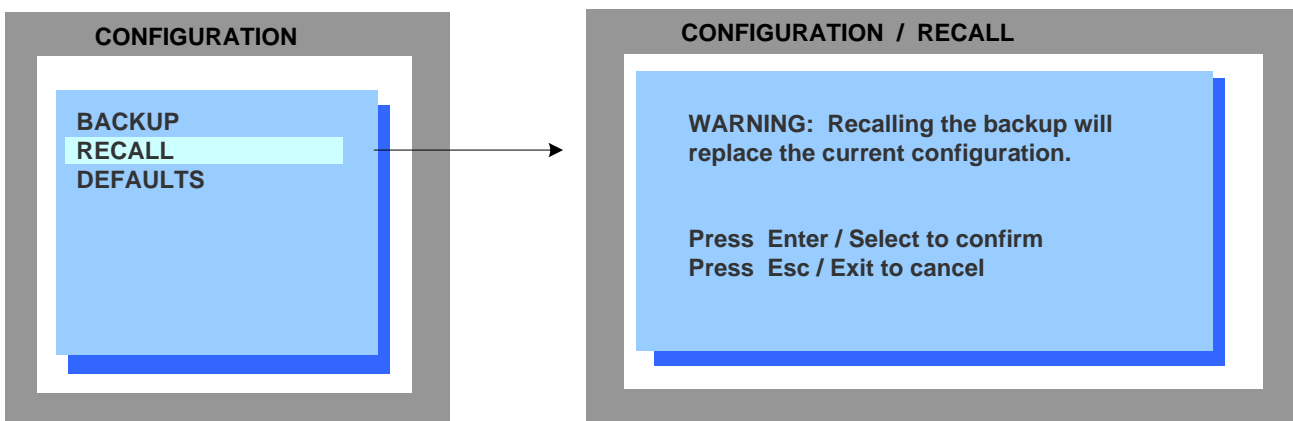

By using the Recall command, the last configuration saved using Backup command will be reloaded and replaces the current settings.

OSD - CONFIGURATION - DEFAULTS

DEFAULTS

Use arrow keys to navigate in the Configuration menu to the DEFAULTS line and press Enter / select to open the Defaults window.

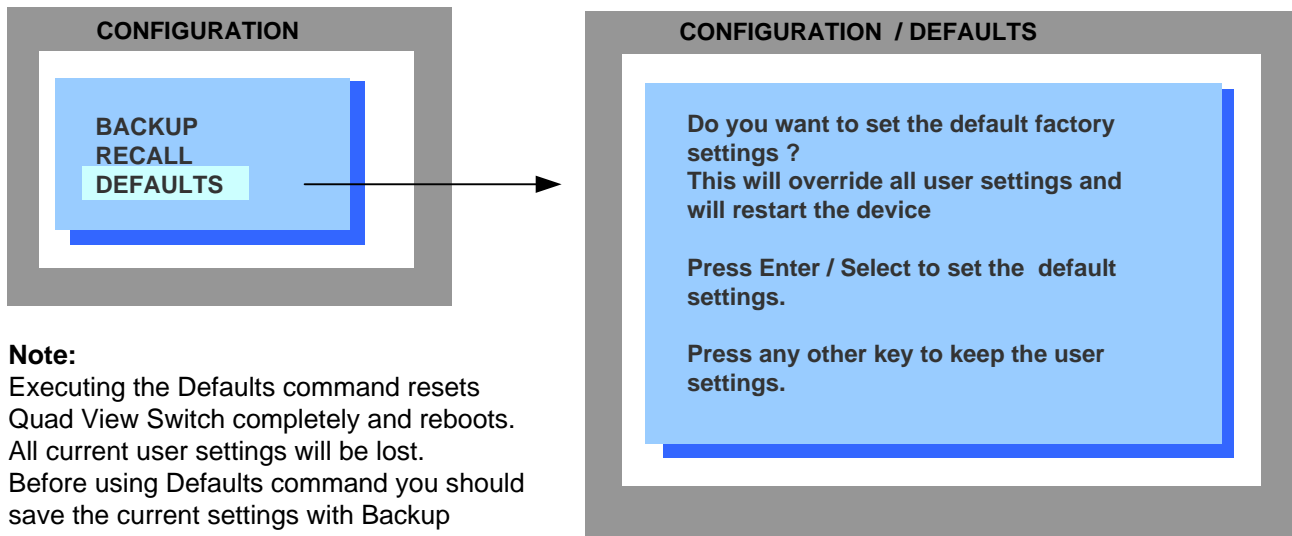

Note:

Executing the Defaults command resets Quad View Switch completely and reboots. All current user settings will be lost. Before using Defaults command you should save the current settings with Backup command.

FACTORY DEFAULTS

SYSTEM	HOTKEY	= Multiple Hotkey / Hotkey = Strg + Alt
	HOTMOUSE	= On / Hotmouse timeout = 5 sec.
	QUAD MODE	Channel select timeout = 5 sec.
	OSD POSITION	= centered
	OSD LANGUAGE	= English
	SECURITY	= none (security level = 0)
MODE	PIP	Size = 15 % ; Zoom factor = 1;
		Display mode = triple; Active channel = gap;
		Offset from top = 0 %;
	START	Start setting = Quad / active channel = 1
CONSOLE	VIDEO OUTPUT	= auto
	KEYBOARD	= English
	MULTI MONITOR	Monitor 1 → Channel 1; Monitor 2 → Channel 2;
		Monitor 3 → Channel 3; Monitor 4 → Channel 4
VIDEO	VIDEO INPUT	= DVI / VGA (all channels)
	BRIGHTNESS	= 58,2 % (all analog channels)
	CONTRAST	= 63,5 % (all analog channels)
	HORIZ POSITION	= auto (all channels)
	VERT POSITION	= auto (all channels)
	SCREEN WIDTH	= +0 (all analog channels)
	PHASE	= +0 (all analog channels)
	FORMAT	= No (all channels)
COMPUTER	MOUSE	USB mouse positioning = relative (all channels)

OSD - CONSOLE

VIDEO OUTPUT

Use arrow keys to navigate in CONSOLE menu to the VIDEO OUTPUT line and press Enter / select to open the Video Output window.

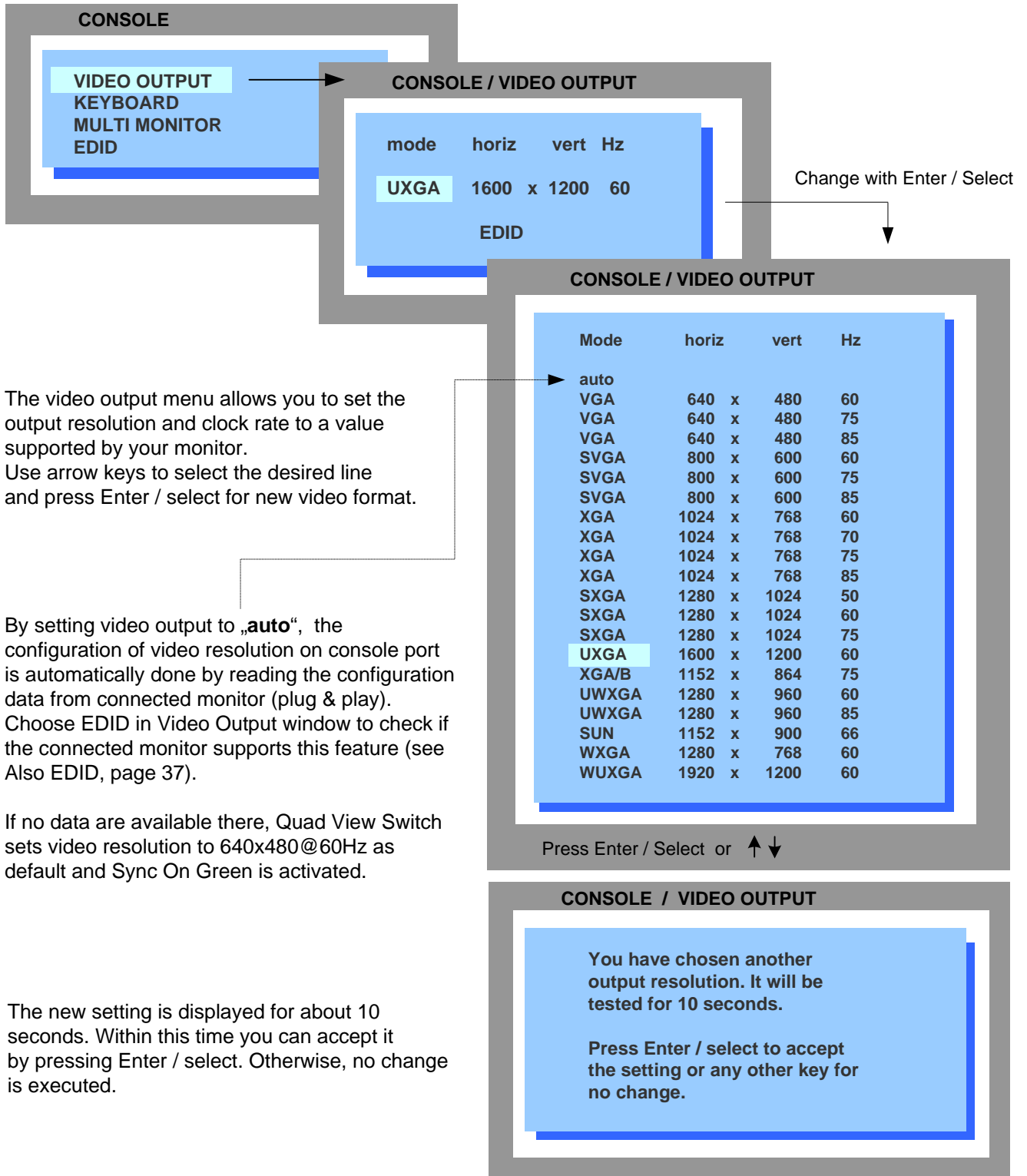

The video output menu allows you to set the output resolution and clock rate to a value supported by your monitor. Use arrow keys to select the desired line and press Enter / select for new video format.

By setting video output to „auto“, the configuration of video resolution on console port is automatically done by reading the configuration data from connected monitor (plug & play). Choose EDID in Video Output window to check if the connected monitor supports this feature (see Also EDID, page 37).

If no data are available there, Quad View Switch sets video resolution to 640x480@60Hz as default and Sync On Green is activated.

The new setting is displayed for about 10 seconds. Within this time you can accept it by pressing Enter / select. Otherwise, no change is executed.

ON SCREEN DISPLAY

OSD - CONSOLE

KEYBOARD

Use arrow keys to navigate in CONSOLE menu to the KEYBOARD line and press Enter / select to open the Keyboard window. You can set the keyboard layout to English or Deutsch (German).

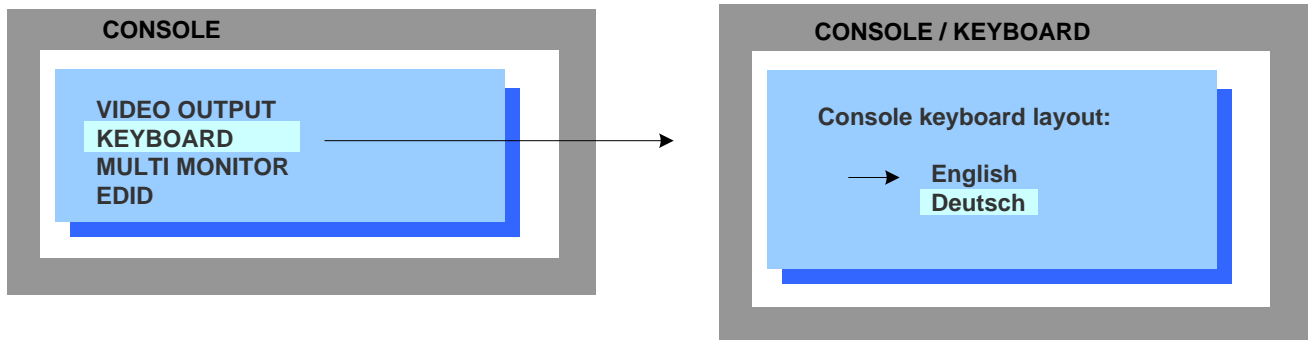

MULTI MONITOR

Use arrow keys to navigate in CONSOLE menu to the MULTI MONITOR line and press Enter / select to open the Multi Monitor window.

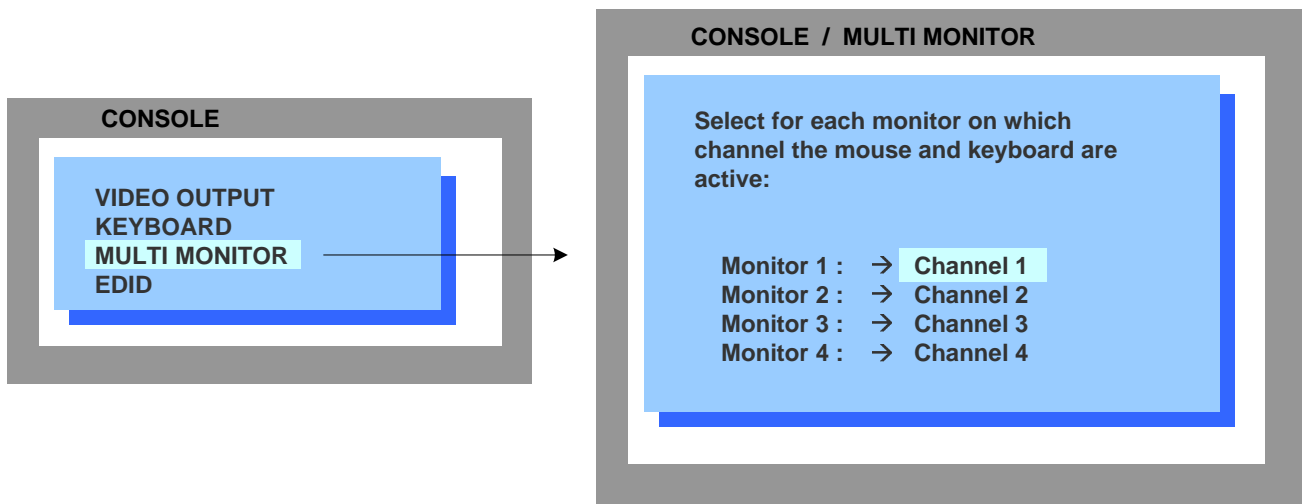

If you use graphics cards with multiple video outputs, you should assign the computer's mouse and keyboard to the corresponding input (channel 1-4), where mouse and keyboard are connected. If for example a computer with quad graphics card is connected at Quad View Switch you have to configure the correlation in this way:

Monitor 1 : → Channel 1
Monitor 2 : → Channel 1
Monitor 3 : → Channel 1
Monitor 4 : → Channel 1

Keyboard and mouse are connected to channel 1 input.

OSD - CONSOLE

EDID

Use arrow keys to navigate in CONSOLE menu to the EDID line and press Enter / select to open the EDID window.

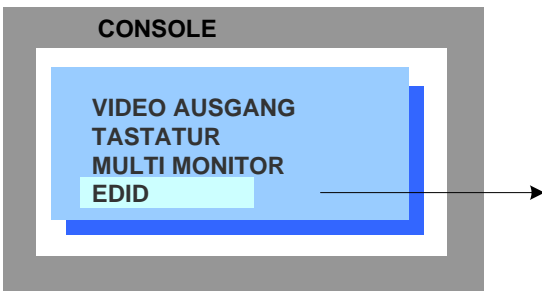

Use EDID command to read and display the EDID data of your console monitor.

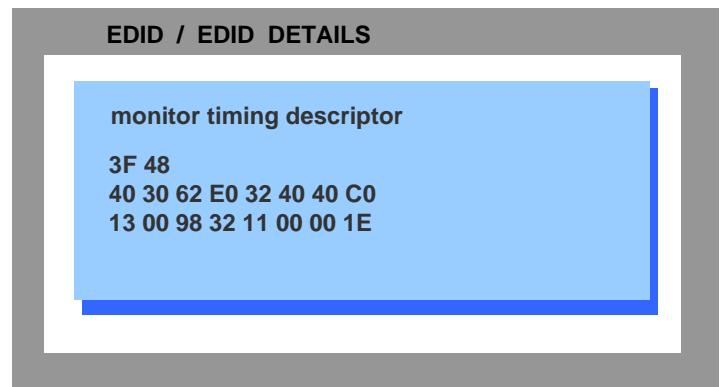
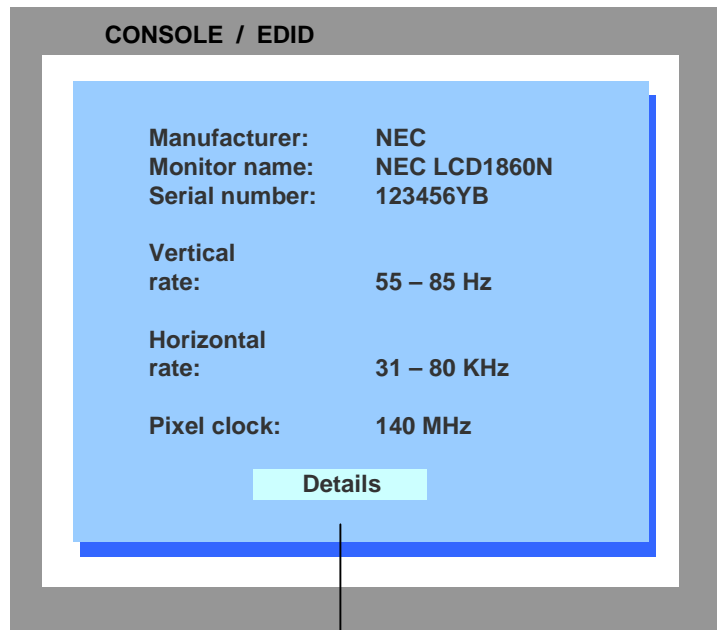

Extended Display Identification Data is a VESA standard data format that contains basic information about a monitor and its capabilities, including vendor information, maximum image size, color characteristics, factory preset timings, frequency range limits, and character strings for the monitor name and serial number. The information is stored in the display and is used to communicate with the system through a Display Data Channel (DDC), which is situated between the monitor and the PC graphics adapter. The system uses this information for configuration purposes, so the monitor and system can work together.

ON SCREEN DISPLAY

OSD - VIDEO

VIDEO INPUT (Show video formats)

Use arrow keys to navigate in COMPUTER menu to the VIDEO INPUT line and press Enter / select to open the Video Input window.

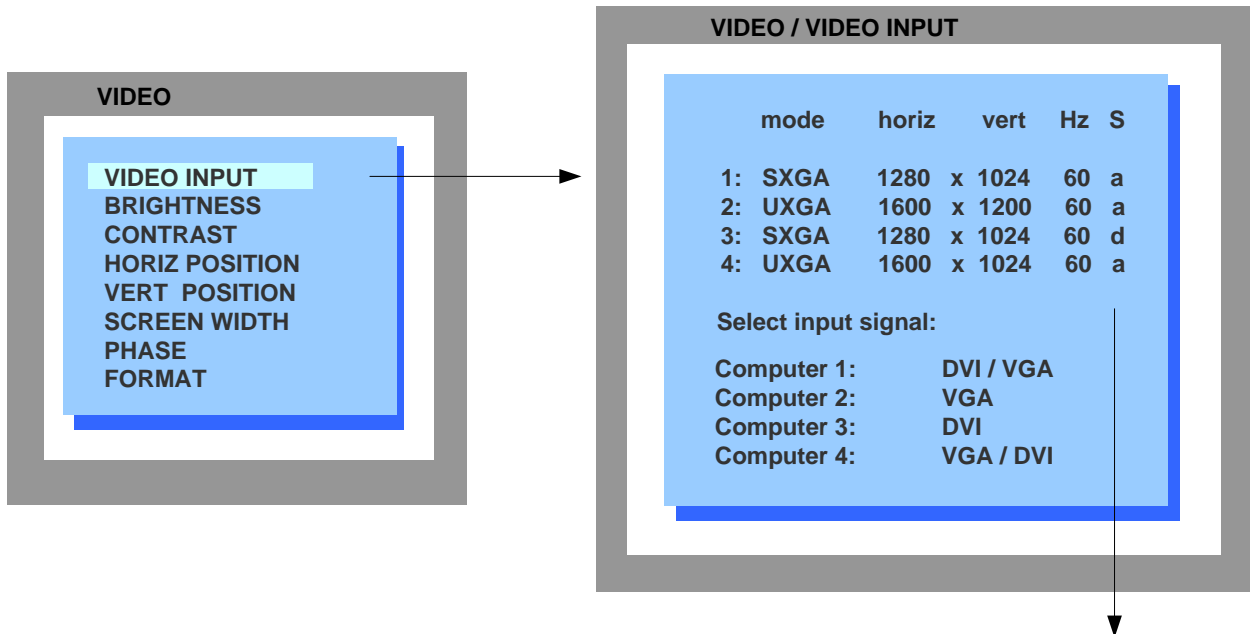

The upper part of window displays video formats that Quad View Switch has automatically recognized at the four video inputs (Plug & Play).

In the lower part of the window you define which video input is selected for display. If both signal inputs DVI/VGA or VGA/DVI are selected, the first one will be processed and displayed. If there is no signal present the other automatically will be selected and processed.

S = Signal

a = analog
 d = digital
 g = sync on green
 c = comp. sync

The following video formats are supported:

MODE	RESOLUTION	RATE	MODE	RESOLUTION	RATE
CGA	640 x 350	85	XGA	1024 x 768	75
CGA	640 x 400	85	XGA	1024 x 768	85
EGA	720 x 400	70	XGA/B	1152 x 864	75
EGA	720 x 400	85	SUN	1152 x 900	66
VGA	640 x 480	60	WXGA 60	1280 x 768	60
VGA	640 x 480	72	UWXGA 60	1280 x 960	60
VGA	640 x 480	75	UWXGA 85	1280 x 960	85
VGA	640 x 480	85	SXGA 50	1280 x 1024	50
SVGA	800 x 600	56	SXGA 60	1280 x 1024	60
SVGA	800 x 600	60	SXGA 72	1280 x 1024	72
SVGA	800 x 600	72	SXGA 75	1280 x 1024	75
SVGA	800 x 600	75	SXGA 85	1280 x 1024	85
SVGA	800 x 600	85	SGI	1600 x 1024	60
XGA	1024 x 768	60	UXGA 50	1600 x 1200	50
XGA	1024 x 768	70	UXGA 60	1600 x 1200	60
			WUXGA 60	1920 x 1200	60 (digital only)

OSD - VIDEO

BRIGHTNESS - CONTRAST

Use arrow keys to navigate in VIDEO menu to the BRIGHTNESS / CONTRAST line and press Enter / select to open the Brightness / Contrast window.

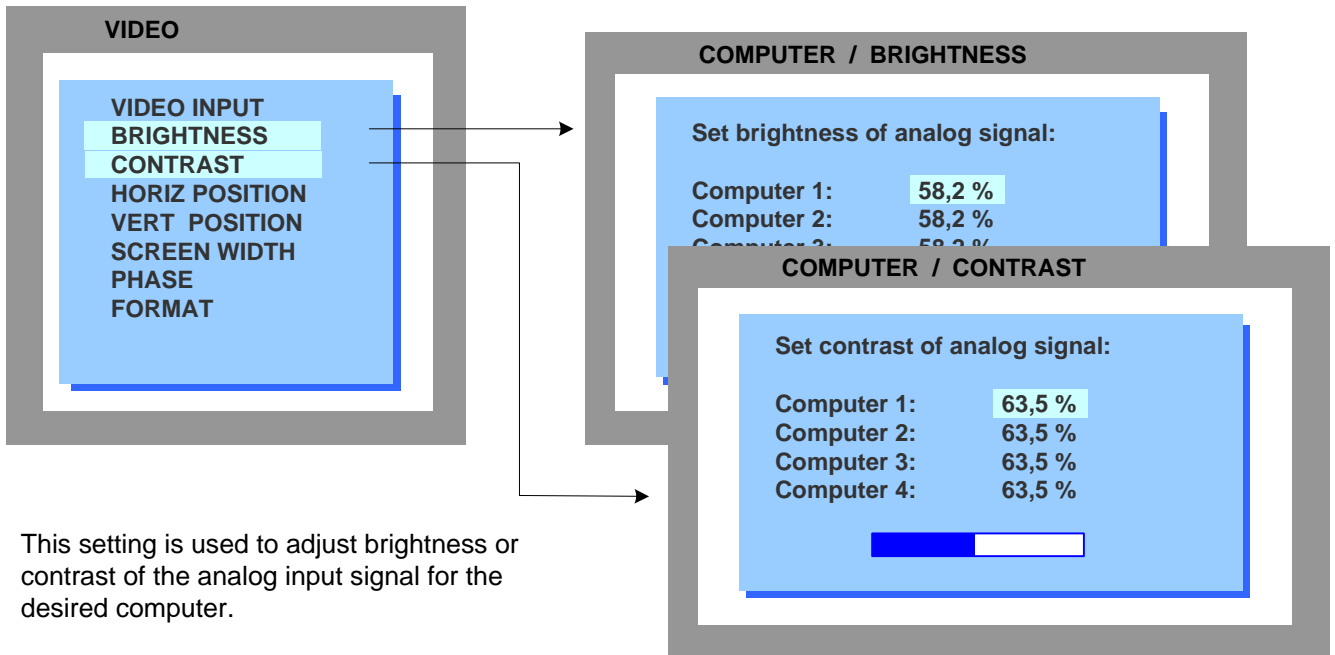

This setting is used to adjust brightness or contrast of the analog input signal for the desired computer.

HORIZONTAL / VERTICAL POSITION

Use arrow keys to navigate in VIDEO menu to the HORIZ POSITION or VERT POSITION line and press Enter / select to open the Horizontal / Vertical Position window.

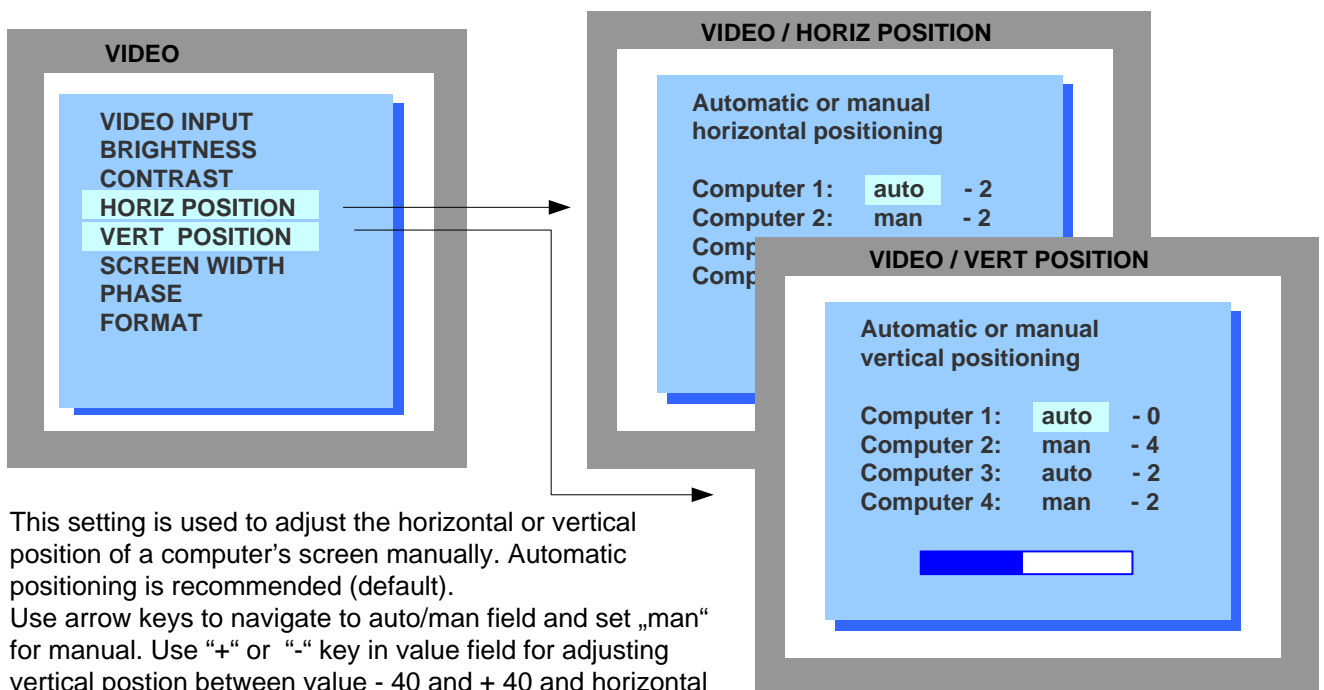

This setting is used to adjust the horizontal or vertical position of a computer's screen manually. Automatic positioning is recommended (default). Use arrow keys to navigate to auto/man field and set „man“ for manual. Use “+“ or “-“ key in value field for adjusting vertical position between value - 40 and + 40 and horizontal position between - 20 and + 20.

ON SCREEN DISPLAY

OSD - VIDEO

SCREEN WIDTH

Use arrow keys to navigate in VIDEO menu to the SCREEN WIDTH line and press Enter / select to open the Screen width window.

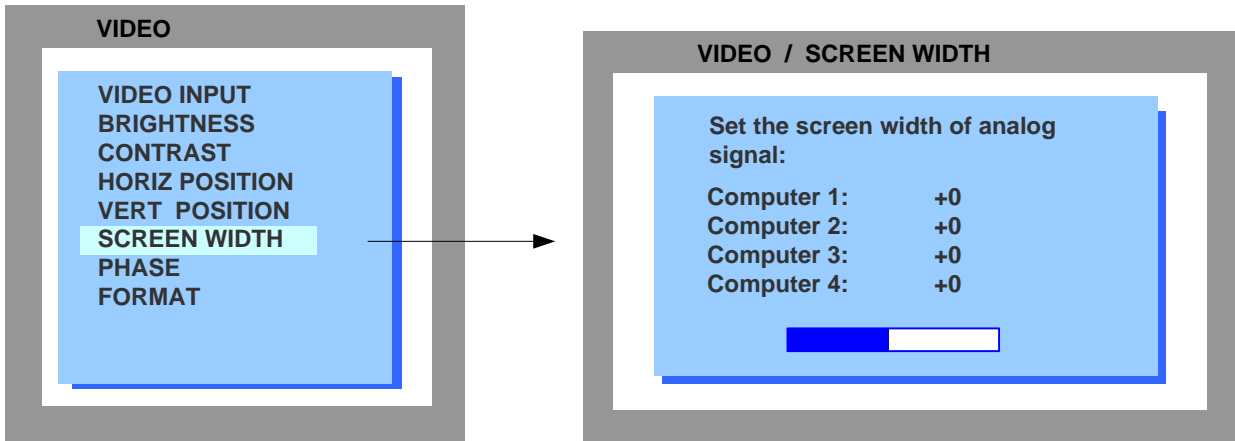

Screen width (number of horizontal pixels) is defined by VESA, if screen is blurring try to improve screen quality by adjusting screen width.

PHASE

Use arrow keys to navigate in VIDEO menu to the PHASE line and press Enter / select to open the Phase window.

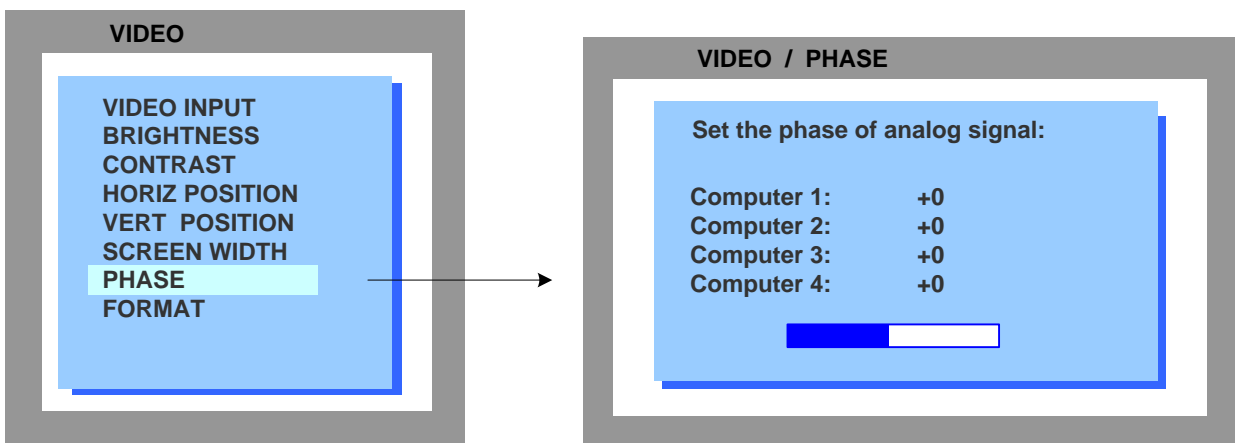

If phasing (sampling instance of pixel) is incorrect (bad contrast, blurring screen, etc.) use this selection to adjust the correct phasing.

OSD - VIDEO - FORMAT

FORMAT

Use arrow keys to navigate in VIDEO menu to the FORMAT line and press Enter / select to open the Format window.

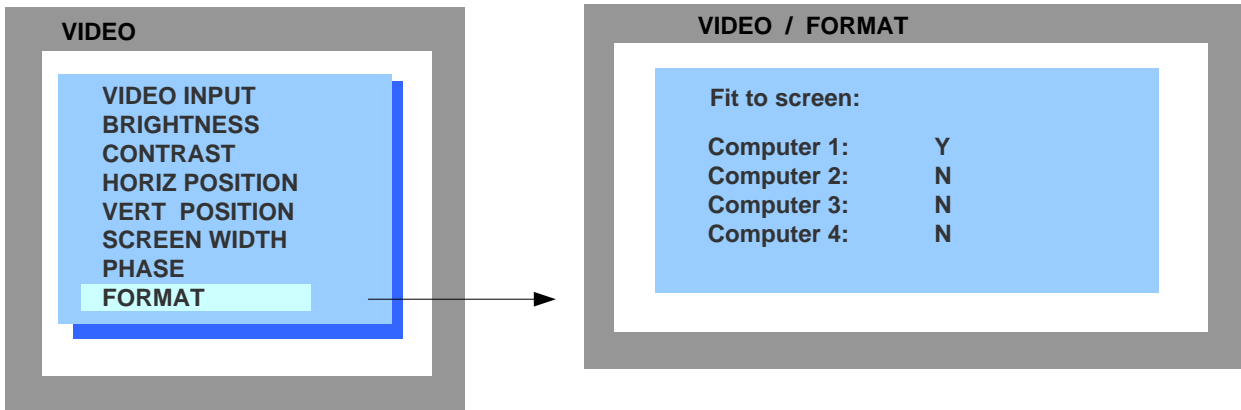

By using a wide screen monitor (for example one with aspect ratio 16:10), an input video with another aspect ratio like 4:3 or 5:4 can be fitted to this monitor size.

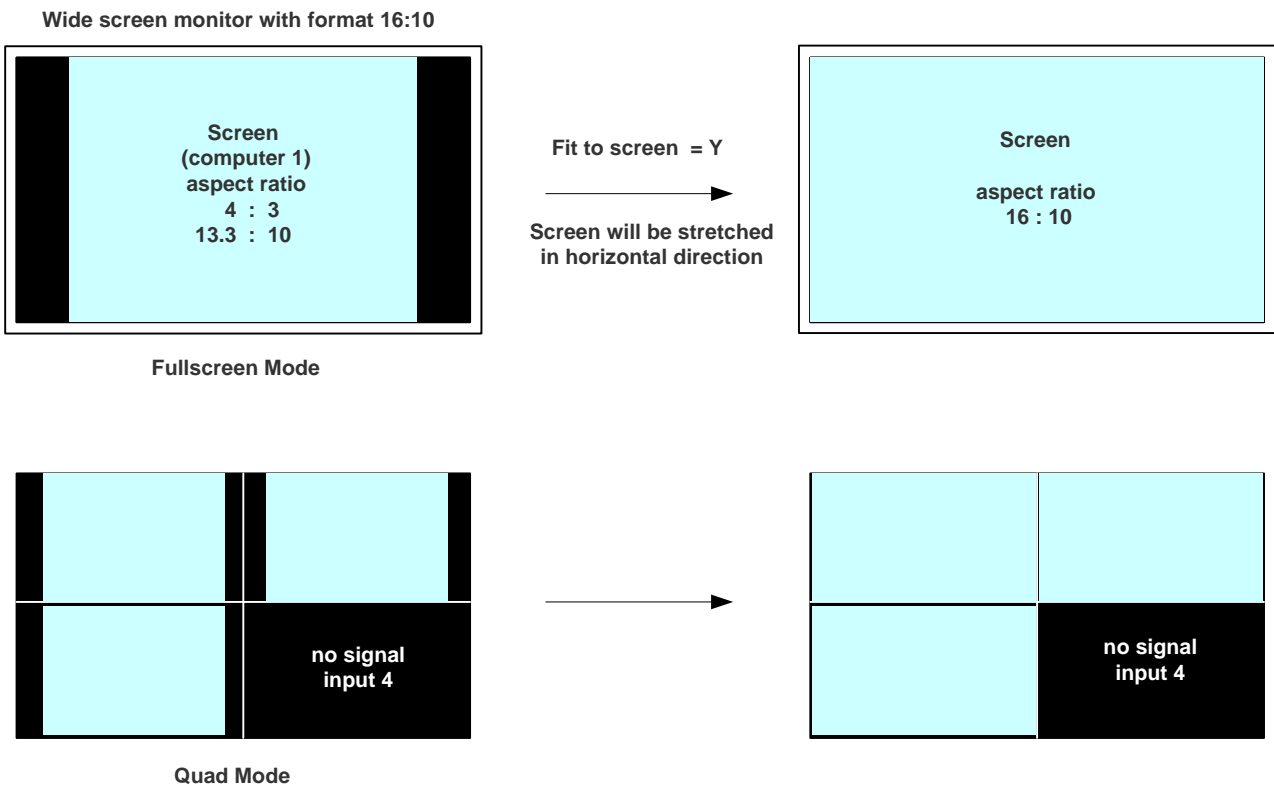

ON SCREEN DISPLAY

OSD - VIDEO - FORMAT

PiP design for wide screen monitors

If you use a wide screen monitor (for example aspect ratio 16:10), then Quad View Switch automatically places video inputs with 4:3, 5:4 or other format to the left hand side of monitor and PiP images to the free area on right hand side. When PiP sizes of 20% or less are configured, PiP images are placed entirely outside of fullscreen.

Wide screen monitor with aspect ratio 16:10

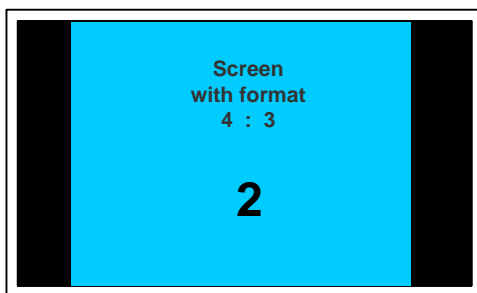

Fullscreen Mode

Fit to screen = N

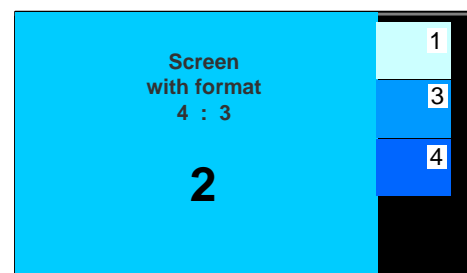

PiP Mode

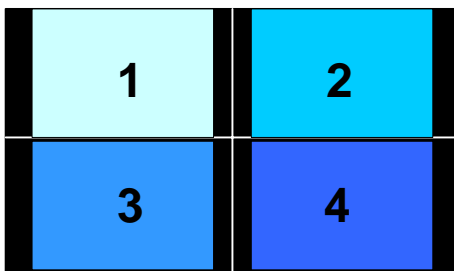

Quad Mode

OSD - COMPUTER

KEYBOARD

Use arrow keys to navigate in COMPUTER menu to the KEYBOARD line and press Enter / select to open the Keyboard window.

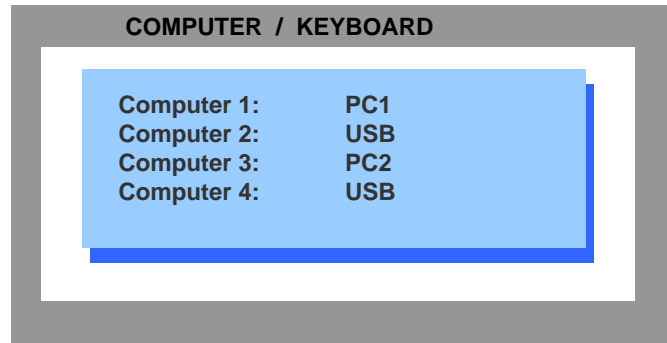
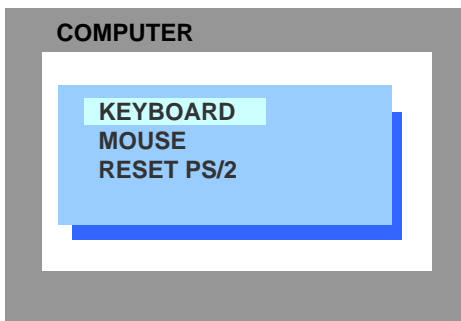

In Keyboard window the recognized keyboard type (USB, PC1, PC2 or PC3) of connected computers are displayed.

MOUSE

Use arrow keys to navigate in COMPUTER menu to the MOUSE line and press Enter / select to open the Mouse window.

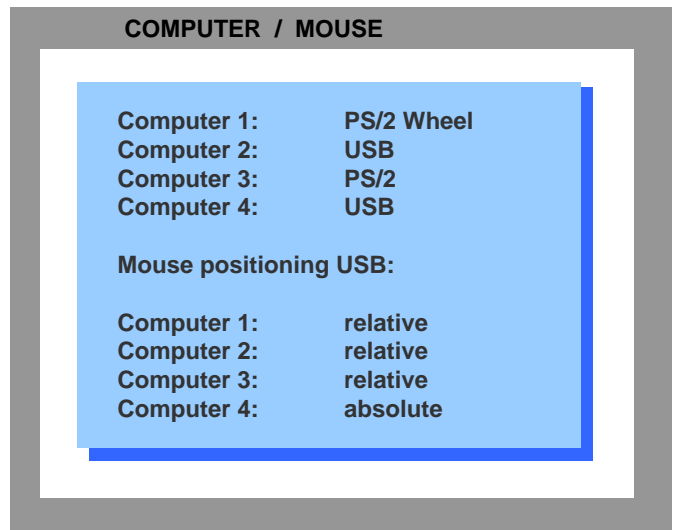
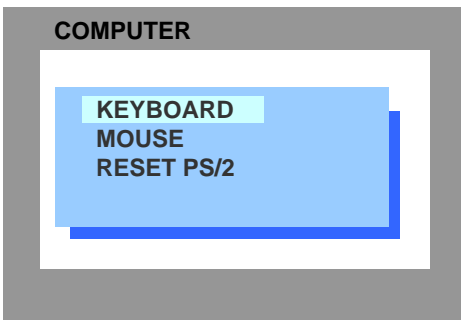

In upper part of window recognized mouse type (USB, PS/2 or PS/2 wheel) of connected computers are displayed.

USB - Mouse positioning

For each computer port where a USB mouse is connected you may define if mouse positioning should work absolute or relative.

Set absolute mouse positioning when a device is connected that supports absolute coordinates like graphic trays, screenpads or KVM extender etc.

ON SCREEN DISPLAY

OSD - COMPUTER - RESET PS/2

RESET PS/2

Use arrow keys to navigate in COMPUTER menu to the RESET PS/2 line and press Enter / select to open the Reset PS/2 window.

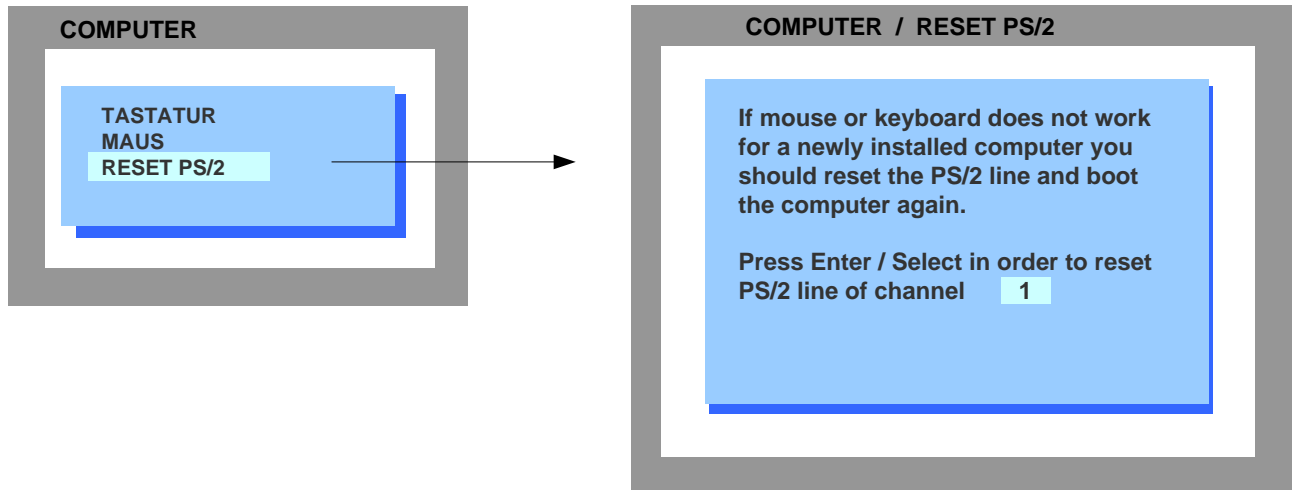

Using arrow keys \leftarrow \rightarrow or $+$ $-$ keys to navigate to channel field, set the desired channel you want to reset and press Enter / select.

OSD - HELP

Use arrow keys to navigate in HELP menu to the desired line and press Enter / select to open the corresponding window.

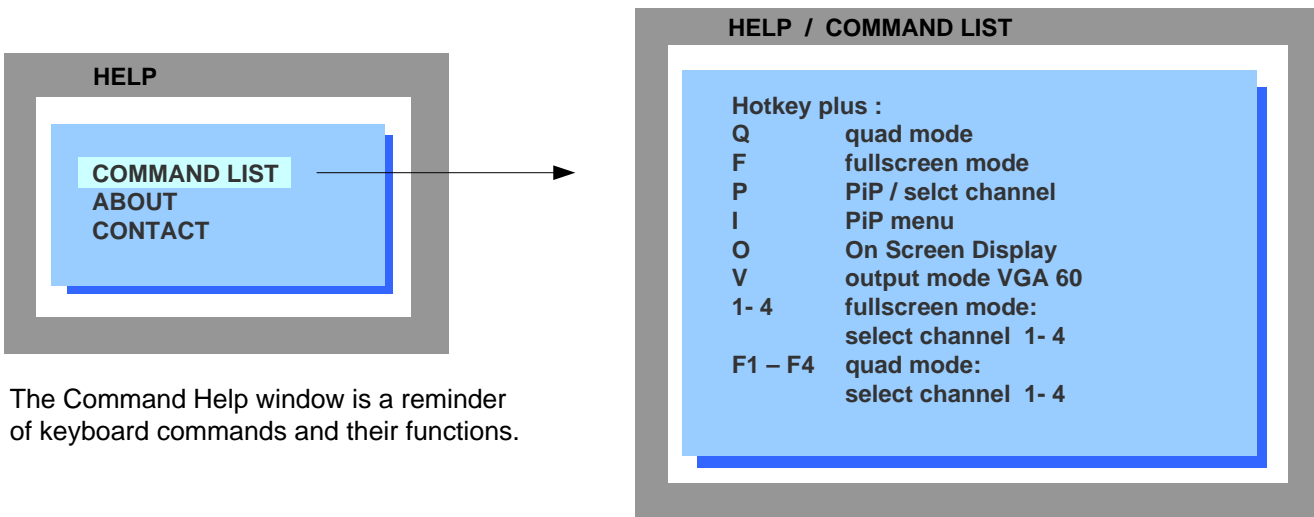

The Command Help window is a reminder of keyboard commands and their functions.

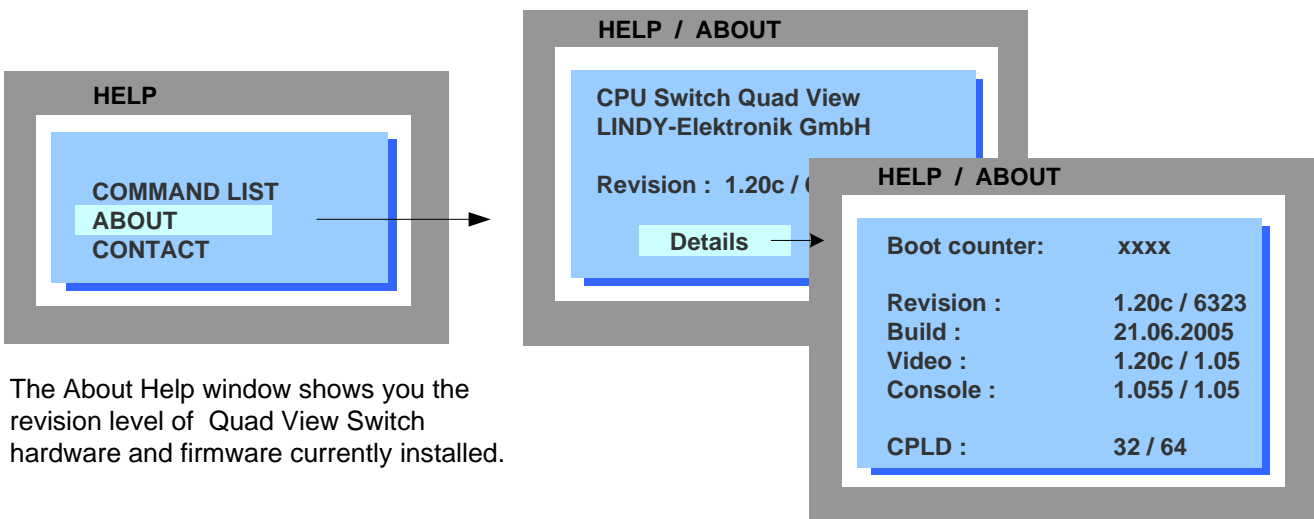

The About Help window shows you the revision level of Quad View Switch hardware and firmware currently installed.

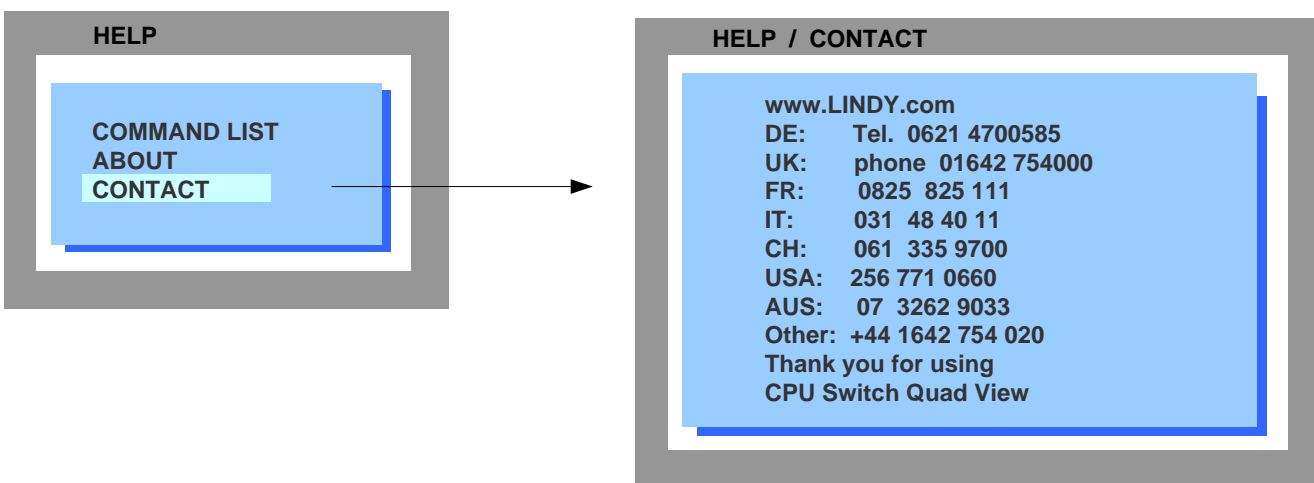

SERVICE

SERVICE INFORMATION

Maintenance and Repair

Quad View Switch does not contain any user serviceable parts inside. Any malfunction of the unit or discrepancies in the operation of the unit should be reported to LINDY's Technical Support Department.

Technical Support

If you are experiencing problems, or need assistance in setting up, configuring or operating your switch, consult the appropriate sections of this manual. If, however, you require additional information or assistance, please contact our Tech Support at:

phone:	DE:	Tel. 0621 4700585
	UK:	phone 01642 754000
	FR:	0825 825 111
	IT:	031 48 40 11
	CH:	061 335 9700
	USA:	256 771 0660
	AUS:	07 3262 9033
	Other:	+44 1642 754 020

Firmware Update

Quad View Switch is equipped with a serial (RS232) port enabling you to upgrade flash firmware.

In order to upgrade Quad View Switch's firmware the following items are required:

- a computer with serial port
- the update program (**updateEn.exe**), which you will find on the enclosed CD.
- a special serial cable (RJ45 - DB9)
- the current firmware file, for example **QuadView_1_20_c.upd**

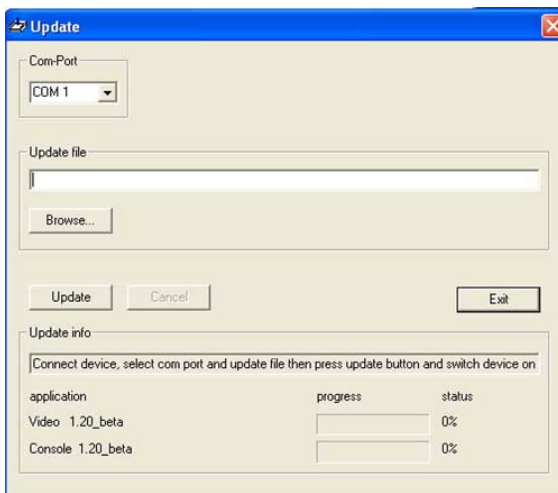
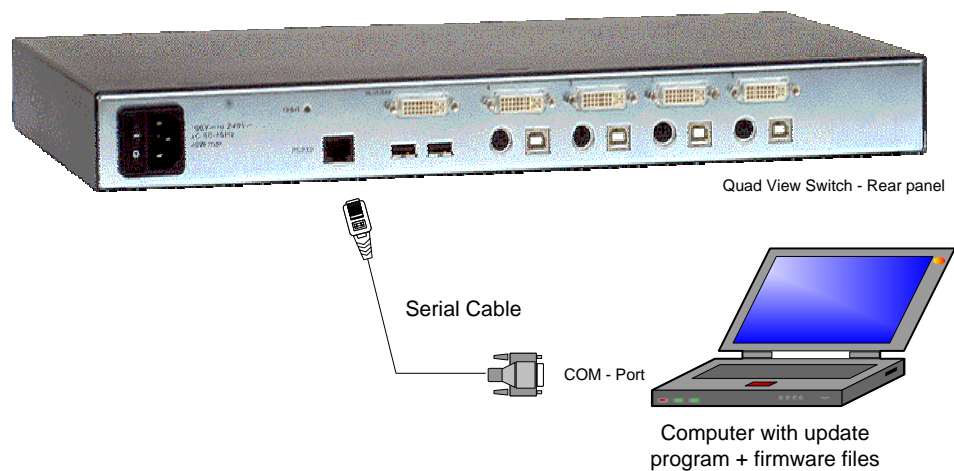

Attach the serial cable from RS232 port on Quad View Switch to a COM port on a computer.

Start the update program (updateEn.exe).

Com-Port: Configure the desired computer COM port

Update file: Enter location (drive and path) of firmware file. Browse function (Browse Icon) can be used.

Click on the **Update** button in order to start the upgrade.

During the upgrade process five LEDs on front panel will flash. Additionally you get upgrade information on OSD window.

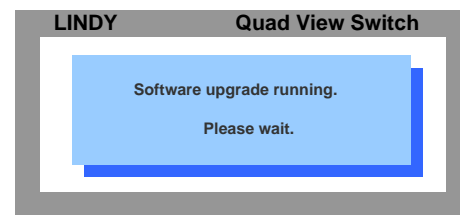

After a successful update, Quad View Switch restarts for operation.

Serial Cable

Quad View Switch - Serial Cable

SERIAL ADAPTER
DB 9 – RJ45
FEMALE

RJ 45 CABLE
MALE

